



Mercedes-Benz



# C-class Operator's Manual

C 240

C 320

Our company and staff congratulate you on the purchase of your new Mercedes-Benz.

Your selection of our product is a demonstration of your trust in our company name. Further, it exemplifies your desire to own an automobile that will be as easy as possible to operate and provide years of service.

Your Mercedes-Benz represents the efforts of many skilled engineers and craftsmen. To ensure your pleasure of ownership, and for your safety and that of your passengers, we ask you to make a small investment of your time:

- Please read this manual carefully before putting it aside. Then return it to your vehicle where it will be handy for your reference.
- Please abide by the recommendations contained in this manual. They are designed to acquaint you with the operation of your Mercedes-Benz.
- Please abide by the warnings and cautions contained in this manual. They are designed to help improve the safety of the vehicle operator and occupants.

We extend our best wishes for many miles of safe, pleasurable driving.

DaimlerChrysler AG

## Introduction

Product information .....	1
Operator's manual .....	2
Where to find it .....	7
Reporting Safety Defects .....	9

## Instruments and controls

Instruments and controls .....	12
Door control panel .....	14
Overhead control panel .....	15
Dashboard .....	16
Center console .....	18

## Operation

Vehicle keys .....	22
Start lock-out .....	24
General notes on the central locking system .....	24
Central locking system .....	25
Radio frequency and infrared remote control .....	25
Locking and unlocking .....	27

Choosing global or selective mode on remote control .....	27
Opening the trunk .....	28
Opening and closing windows and sliding / pop-up roof from outside .....	29
Panic button .....	30
Mechanical keys .....	30
Doors .....	31
Central locking switch .....	33
Automatic central locking .....	34
Emergency unlocking in case of accident .....	34
Trunk .....	35
Trunk lid release switch .....	37
Antitheft alarm system .....	38
Tow-away alarm .....	39
Easy-entry/exit feature .....	41
Front seat adjustment .....	42
Removal and installation of front seat head restraints .....	47
Multicontour seat .....	49
Heated seats .....	50
Rear seat head restraints .....	52

Seat belts and integrated restraint system .....	55
Seat belts .....	55
Seat belt nonusage warning system .....	56
BabySmart™ airbag deactivation system .....	62
Supplemental Restraint System (SRS) .....	63
Emergency tensioning retractor (ETR) .....	64
Airbags .....	65
Safety guidelines for the seat belt, emergency tensioning retractor and airbag .....	72
Infant and child restraint systems .....	73
Steering wheel adjustment (manual) .....	77
Steering wheel adjustment (electrical) .....	79
Rear view mirrors .....	80
Instrument cluster .....	88
Multifunction steering wheel, multifunction display .....	92



## Contents

Trip and main odometer, FSS, coolant temperature, vehicle speed, engine oil level indicator .....	96	Night security illumination .....	132	Sun visors .....	192
Audio systems .....	98	Locator lighting .....	133	Vanity mirrors .....	192
Radio .....	98	Headlamp cleaning system .....	133	Interior .....	193
CD player .....	99	Combination switch .....	134	Storage compartments and armrests .....	193
Cassette player .....	100	Hazard warning flasher switch .....	137	Glove box .....	194
Telephone .....	101	Climate control .....	138	Cup holder .....	197
Navigation system .....	106	Automatic climate control .....	146	Ashtrays .....	199
Trip computer .....	107	Front center console storage compartment ventilation .....	158	Lighter .....	201
Malfunction/warning message memory .....	109	Rear passenger compartment adjustable air outlets .....	159	Parcel net in front passenger footwell .....	202
Individual settings .....	111	Operation Audio and telephone ...	160	Ski sack .....	202
Setting the audio volume .....	123	Operating safety .....	160	Enlarged cargo area .....	207
Coolant temperature gauge .....	124	Operating and display elements .....	161	Split folding rear seat bench .....	207
Flexible service system (FSS) .....	125	Button and soft key operation .....	163	Loading instructions (vehicle with enlarged cargo area) .....	209
Engine oil level indicator .....	128	Operation .....	163	Cellular telephone .....	210
Engine oil consumption .....	129	Power windows .....	184	Telephone, general .....	211
Exterior lamp switch .....	130	Sliding/pop-up roof .....	187	Garage door opener .....	212
Headlamp mode .....	131	Interior lighting .....	189		
		Rear window sunshade .....	191		

## Driving

Control and operation of radio transmitters .....	218
The first 1 000 miles (1 500 km) .....	219
Maintenance .....	219
Tele Aid .....	220
Catalytic converter .....	228
Emission control .....	229
Starter switch .....	230
Starting and turning off the engine .....	232
Manual transmission .....	233
Automatic transmission .....	234
Parking brake .....	243
Driving instructions .....	244
Drive sensibly – Save Fuel .....	244
Drinking and driving .....	244
Pedals .....	244

Power assistance .....	245
Brakes .....	245
Driving off .....	246
Parking .....	246
Tires .....	247
Snow chains .....	250
Winter driving instructions .....	250
Deep water .....	252
Passenger compartment .....	253
Traveling abroad .....	253
Cruise control .....	254
Brake assist system (BAS) .....	257
Antilock brake system (ABS) .....	258
Electronic stability program (ESP) .....	260
What you should know at the gas station .....	264
Check regularly and before a long trip .....	266

## Instrument cluster display

Malfunction and indicator lamps in the instrument cluster .....	268
On-board diagnostic system .....	268
Check engine malfunction indicator lamp .....	268
Brake warning lamp .....	270
Supplemental restraint system (SRS) indicator lamp .....	271
Fuel reserve warning .....	271
ABS malfunction indicator lamp .....	272
Electronic stability program (ESP) – warning lamp .....	273
Seat belt nonusage warning lamp .....	273
Malfunction and indicator lamp in the center console .....	273
AIRBAG OFF indicator lamp .....	273

## Contents

Malfunction and warning messages in the multifunction display ...	274	ENGINE OIL LEVEL .....	283	<b>Practical hints</b>	
DISPLAY DEFECTIVE .....	275	LIGHTING SYSTEM .....	284	First aid kit .....	294
BATTERY / ALTERNATOR .....	276	LIGHT SENSOR .....	286	Stowing things in the vehicle .....	294
ANTILOCK BRAKE SYSTEM .....	277	DOOR .....	286	Fuses .....	295
BRAKE ASSIST .....	277	TRUNK OPEN .....	287	Hood .....	297
BRAKE LINING WEAR .....	278	HOOD .....	287	Checking engine oil level .....	300
BRAKE FLUID .....	278	TELEPHONE - FUNCTION .....	288	Automatic transmission fluid level .....	301
PARKING BRAKE .....	279	TELE AID .....	288	Coolant level .....	301
SEAT BELT SYSTEM .....	279	WASHER FLUID .....	289	Adding coolant .....	302
ELEC. STABIL. PROG. (Electronic stability program) ..	280	RESTRAINT SYSTEM .....	290	Windshield and headlamp washer system .....	302
COOLANT (coolant level) .....	281	KEY .....	290	Spare wheel, vehicle tools, storage compartment .....	304
COOLANT (coolant temperature) .....	282	FUEL RESERVE .....	291	Vehicle jack .....	305
		UNDervOLTAGE .....	291		
		STEER. WHEEL ADJUST. ....	292		
		ENTRANCE POSITION .....	292		

Wheels .....	306	Synchronizing remote control .....	334	Ornamental moldings .....	343
Tire replacement .....	306	Emergency engine shut-down .....	334	Headlamps, taillamps, turn signal lenses .....	343
Rotating wheels .....	307	Fuel filler flap, manual release ...	335	Window cleaning .....	343
Spare wheel .....	308	Replacing wiper blade insert .....	337	Wiper blade .....	343
Changing wheels .....	309	Roof rack .....	338	Light alloy wheels .....	344
Tire inflation pressure .....	315			Instrument cluster .....	344
Battery .....	316			Steering wheel and gear selector lever .....	344
Jump starting .....	318	<b>Vehicle care</b>		Cup holder .....	344
Towing the vehicle .....	321	Cleaning and care of the vehicle .....	340	Seat belts .....	345
Transmission selector lever, manually unlocking .....	325	Power washer .....	341	Headliner and shelf below rear window .....	345
Exterior lamps .....	326	Tar stains .....	341	Leather upholstery .....	345
Replacing bulbs .....	326	Paintwork, painted body components .....	341	Hard plastic trim items .....	345
Trunk lamp .....	331	Engine cleaning .....	342	Plastic and rubber parts .....	345
Changing batteries in the electronic main key .....	332	Vehicle washing .....	342		

## Technical data

Spare parts service .....	348
Warranty coverage .....	348
Identification labels .....	349
Layout of poly-V-belt drive .....	350
Technical data .....	351
Fuels, coolants, lubricants etc. - capacities .....	355
Engine oils .....	357

Engine oil additives .....	357
Air conditioner refrigerant .....	357
Brake fluid .....	357
Premium unleaded gasoline .....	358
Fuel requirements .....	358
Gasoline additives .....	359
Coolants .....	359
Consumer information .....	361
Uniform tire quality grading .....	361

## Index

Index.....	364
------------	-----

## **Product information**

Kindly observe the following in your own best interest:

We recommend using Mercedes-Benz original parts as well as conversion parts and accessories explicitly approved by us for your vehicle model.

We have tested these parts to determine their reliability, safety and their special suitability for Mercedes-Benz vehicles.

We are unable to make an assessment for other products and therefore cannot be held responsible for them, even if in individual cases an official approval or authorization by governmental or other agencies should exist. Use of such parts and accessories could adversely affect the safety, performance or reliability of your vehicle. Please do not use them.

Mercedes-Benz original parts as well as conversion parts and accessories approved by us are available at your authorized Mercedes-Benz Center where you will receive comprehensive information, also on permissible technical modifications, and where proper installation will be performed.

### **Operator's manual**

This Operator's Manual contains a great deal of useful information. We urge you to read it carefully and familiarize yourself with the vehicle before driving.

For your own safety and longer service life of the vehicle, we urge you to follow the instructions and warnings contained in this manual. Ignoring them could result in damage to the vehicle or personal injury to you or others. Vehicle damage caused by failure to follow instructions is not covered by the Mercedes-Benz Limited Warranty.

Your vehicle may have some or all of the equipment described in this manual. Therefore, you may find explanations for optional equipment not installed in your vehicle. If you have any questions about the operation of any equipment, your authorized Mercedes-Benz Center will be glad to demonstrate the proper procedures.

### **Service and warranty information**

The Service and Warranty Information Booklet contains detailed information about the warranties covering your Mercedes-Benz, including:

- New Car Limited Warranty,
- Emission System Warranty,
- Emission Performance Warranty,
- California, Massachusetts, and Vermont Emission Control System Warranty (California, Massachusetts, and Vermont only),
- State Warranty Enforcement Laws (Lemon Laws).

### **Important notice for California retail buyers of Mercedes-Benz automobiles**

Under California law you may be entitled to a replacement of your vehicle or a refund of the purchase price, if Mercedes-Benz USA, LLC or its authorized Mercedes-Benz Center fails to conform the vehicle to its express warranties after a reasonable number of repair attempts during the period of one year or 12 000 miles from original delivery of the vehicle. A reasonable number of repair attempts is presumed for a retail buyer (1) if the vehicle is out of service by reason of repair of substantial nonconformities for a cumulative total of more than 30 calendar days or (2) the same substantial non-conformity has been subject to repair four or more times **and you have at least once directly notified us in writing of the need to repair the non-conformity and have given us an opportunity to perform the repair ourselves. Notifications should be sent to the nearest Mercedes-Benz Regional Office listed in the Service and Warranty Information Booklet.**

### **Maintenance**

The Service Booklet describes all the necessary maintenance work which should be performed at regular intervals.

Always have the Service Booklet with you when you take the vehicle to your authorized Mercedes-Benz Center for service. The service advisor will record each service in the booklet for you.



**Roadside assistance**

The Mercedes-Benz Roadside Assistance Program provides factory trained technical help in the event of a breakdown. Calls to the toll-free Roadside Assistance number:

**1-800-FOR-MERCEdes (in the USA)**

**1-800-387-0100 (in Canada)**

will be answered by Mercedes-Benz Client Assistance Representatives 24 hours a day, 365 days a year.

For additional information refer to the Mercedes-Benz Roadside Assistance Program brochure in your glove box.

**Change of address or ownership**

If you change your address, be sure to send in the “Change of Address Notice” found in the Service and Warranty Information Booklet, or simply call the Mercedes-Benz Client Assistance Center (in the USA) at 1-800-FOR-MERCEdes, or Customer Service (in Canada) at 1-800-387-0100. It is in your own interest that we can contact you should the need arise.

If you sell your Mercedes, please leave all literature with the vehicle to make it available to the next operator.

If you bought this vehicle used, be sure to send in the “Notice of Purchase of Used Car” found in the Service and Warranty Information Booklet, or call the Mercedes-Benz Client Assistance Center (in the USA) at 1-800-FOR-MERCEdes, or Customer Service (in Canada) at 1-800-387-0100.

## **Operating your vehicle outside the USA or Canada**

If you plan to operate your vehicle in foreign countries, please be aware that:

- Service facilities or replacement parts may not be readily available,
- unleaded gasoline for vehicles with catalytic converters may not be available; the use of leaded fuels will damage the catalyts,
- gasoline may have a considerably lower octane rating, and improper fuel can cause engine damage.

Certain Mercedes-Benz models are available for delivery in Europe under our European Delivery Program. For details, consult your authorized Mercedes-Benz Center or write to:

In the USA:

Mercedes-Benz USA, LLC  
European Delivery Department  
One Mercedes Drive  
Montvale, NJ 07645-0350

In Canada:

Mercedes-Benz Canada, Inc.  
European Delivery Department  
849 Eglinton Avenue East  
Toronto, Ontario M4G 2L5

We continuously strive to improve our product, and ask for your understanding that we reserve the right to make changes in design and equipment. Therefore, information, illustrations and descriptions in this Operator's Manual might differ from your vehicle.

Optional equipment is also described in this manual, including operating instructions wherever necessary. Since they are special-order items, the descriptions and illustrations herein may vary slightly from the actual equipment of your vehicle.

If there are any equipment details that are not shown or described in this Operator's Manual, your authorized Mercedes-Benz Center will be glad to inform you of correct care and operating procedures.

The Operator's Manual and Service Booklet are important documents and should be kept with the vehicle.

## Where to find it

The Operator's Manual is divided into eight sections:

- **Instruments and controls:** An overview of all the controls that can be operated from the driver's seat.
- **Operation:** Information on the vehicle's equipment and its operation.
- **Driving:** Important information on driving.
- **Instrument cluster display:** Displays and indicator lamps on the instrument cluster with brief instructions.
- **Practical hints:** Assistance and instructions in the event of an emergency.
- **Car care:** Instructions on caring for your vehicle.
- **Technical data:** All the important technical data for your vehicle as well as consumer information such as fuels, coolants, lubricants etc. is contained here.
- **Index:** Key terms to help you find a topic quickly.

Other documents may also be supplied, depending on your vehicle's equipment.

Explanation of color used:

Warning notices for the protection of yourself and others appear on red background.

### **Problems with your vehicle**

If you should experience a problem with your vehicle, particularly one that you believe may affect its safe operation, we urge you to immediately contact your authorized Mercedes-Benz Center to have the problem diagnosed and corrected if required. If the matter is not handled to your satisfaction, please discuss the problem with the Mercedes-Benz Center management, or if necessary contact us at the following addresses:

In the USA: Client Assistance Center  
Mercedes-Benz USA, LLC  
One Mercedes Drive  
Montvale, NJ 07645-0350

In Canada: Customer Relations Department  
Mercedes-Benz Canada, Inc.  
849 Eglinton Avenue East  
Toronto, Ontario, M4G 2L5

For the USA only:

The following text is published as required of manufacturers under Title 49, Code of U.S. Federal Regulations, Part 575 pursuant to the “National Traffic and Motor Vehicle Safety Act of 1966”.

## **Reporting Safety Defects**

If you believe that your vehicle has a defect which could cause a crash or could cause injury or death, you should immediately inform the National Highway Traffic Safety Administration (NHTSA) in addition to notifying Mercedes-Benz USA, LLC.

If NHTSA receives similar complaints, it may open an investigation, and if it finds that a safety defect exists in a group of vehicles, it may order a recall and remedy campaign. However, NHTSA cannot become involved in individual problems between you, your retailer, or Mercedes-Benz USA, LLC.

To contact NHTSA, you may either call the Auto Safety Hotline toll-free at 1-800-424-9393 (or 366-0123 in Washington, D.C. area) or write to: NHTSA, U.S. Department of Transportation, Washington, D.C. 20590. You can also obtain other information about motor vehicle safety from the Hotline.



## **Instruments and controls**

Instruments and controls .....	12
Door control panel .....	14
Overhead control panel .....	15
Dashboard .....	16
Center console .....	18



Instruments and controls

Instruments and controls



**1** Door control panel, see page 14

**2** Overhead control panel, see page 15

**3** Dashboard, see page 16

**4** Center console, see page 18

## Instruments and controls

14

## Door control panel



- 1 Door handle, pull to open, see page 31
- 2 Memory function (for storing seat, steering wheel and exterior rear view mirror settings), see page 85
- 3 Front seat adjustment, see page 42
- 4 Steering wheel adjustment, see page 79
- 5 Power windows, see page 184
- 6 Switch for rear door window override, see page 184 and 186
- 7 Trunk lid release switch, see page 37

## Overhead control panel

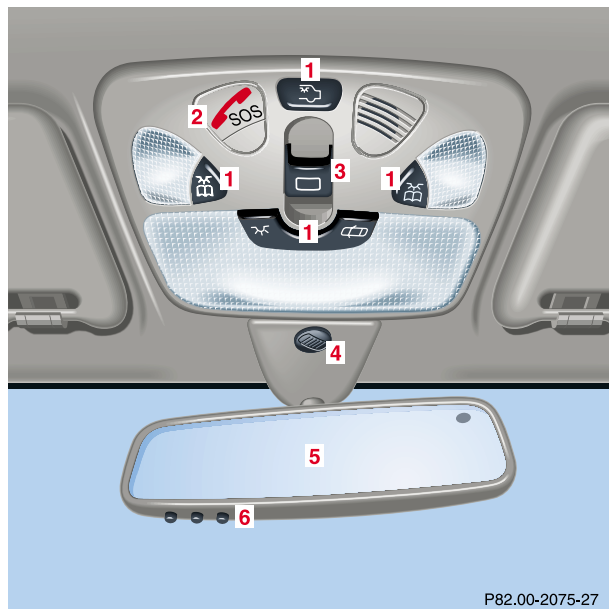

- 1 Interior lighting, see page 189
- 2 Tele Aid (emergency call system), see page 220
- 3 Sliding/pop-up roof, see page 187
- 4 Hands-free microphone for Tele Aid and optional telephone with voice recognition system
- 5 Rear view mirror, see page 80
- 6 Garage door opener, see page 212

Instruments and controls

Dashboard

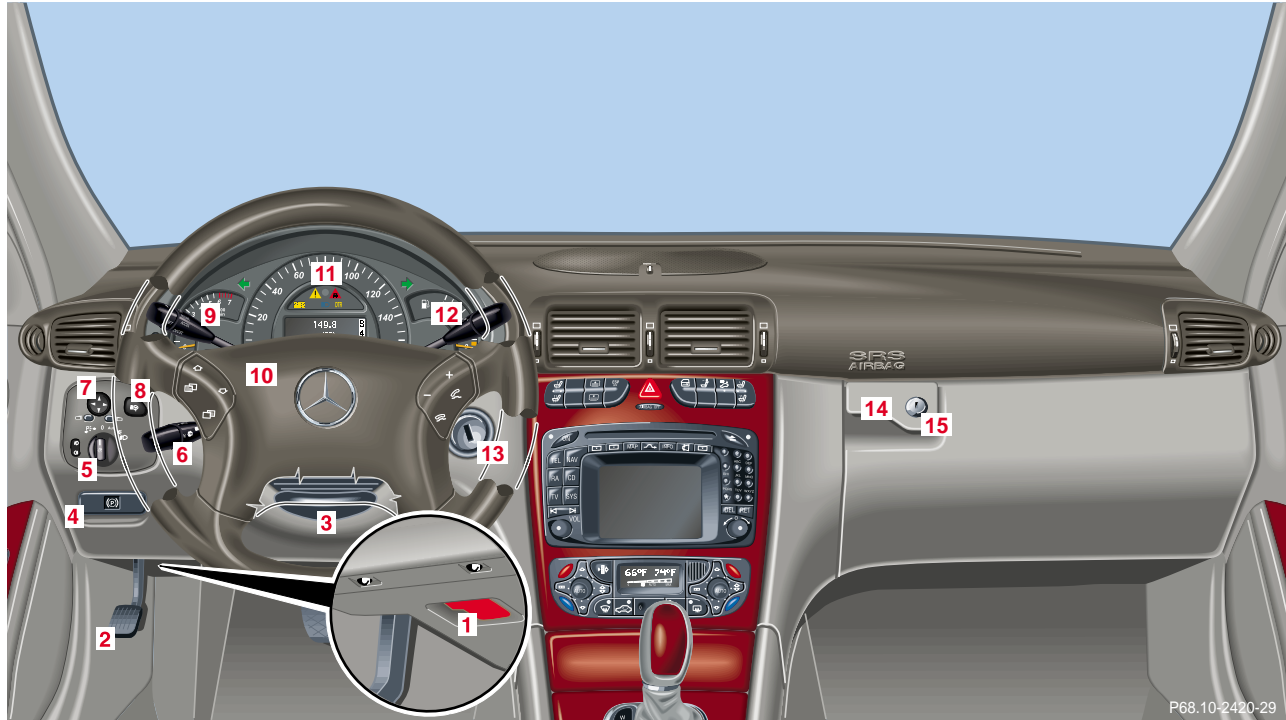

- 1 Hood lock release, see page 297
- 2 Parking brake pedal, see page 243
- 3 Steering wheel adjustment (manual), see page 77
- 4 Parking brake release, see page 243
- 5 Exterior lamp switch, see page 130
- 6 Combination switch, see page 134
- 7 Exterior mirror adjustment, see page 81
- 8 Headlamp washer button, see page 133
- 9 Cruise control switch, see page 254
- 10 Multifunction steering wheel, see page 92  
Horn (with electronic key in starter switch position 1 or 2)
- 11 Instrument cluster, see page 88
- 12 Voice recognition system switch, see separate operating instructions
- 13 Starter switch, see page 230
- 14 Glove box lid release, see page 194
- 15 Glove box lock, see page 194

## Instruments and controls

## Center console

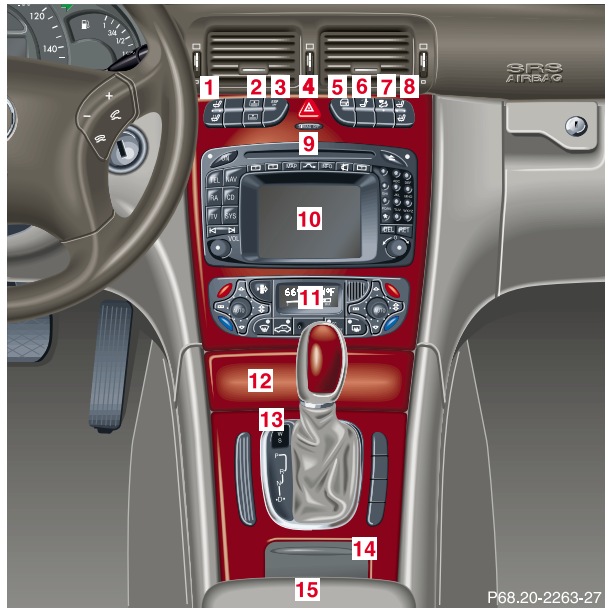

## 18

- 1 Left front seat heater switch, see page 50
- 2 Rear window sunshade (optional), see page 191
- 3 ESP (electronic stability program) control switch, see page 260
- 4 Hazard warning flasher switch, see page 137
- 5 Central locking switch, see page 33
- 6 Rear seat head restraints, see page 52
- 7 Antitheft alarm system, see page 38  
Switch for tow-away protection, see page 39
- 8 Right front seat heater switch, see page 50
- 9 AIRBAG OFF indicator lamp, see page 273
- 10 COMAND system (optional), see separate operating instructions, or audio system, see page 160
- 11 Climate control (C 240), see page 138  
Automatic climate control (C 320) see page 146  
Rear window defroster, see page 157

**12** Ashtray, see page 199

**13** Automatic transmission, see page 234, or  
Manual transmission, see page 233

**14** Storage compartment, see page 195

**15** Armrest, see page 195  
Storage compartment, see page 201



## Contents - Operation

20

**Operation**

Vehicle keys .....	22	Antitheft alarm system .....	38	Infant and child restraint systems .....	73
Start lock-out .....	24	Tow-away alarm .....	39	Steering wheel adjustment (manual) .....	77
General notes on the central locking system .....	24	Easy-entry/exit feature .....	41	Steering wheel adjustment (electrical) .....	79
Central locking system .....	25	Front seat adjustment .....	42	Rear view mirrors .....	80
Radio frequency and infrared remote control .....	25	Removal and installation of front seat head restraints .....	47	Instrument cluster .....	88
Locking and unlocking .....	27	Multicontour seat .....	49	Multifunction steering wheel, multifunction display .....	92
Choosing global or selective mode on remote control .....	27	Heated seats .....	50	Trip and main odometer, FSS, coolant temperature, vehicle speed, engine oil level indicator .....	96
Opening the trunk .....	28	Rear seat head restraints .....	52	Audio systems .....	98
Opening and closing windows and sliding / pop-up roof from outside .....	29	Seat belts and integrated restraint system .....	55	Radio .....	98
Panic button .....	30	Seat belts .....	55	CD player .....	99
Mechanical keys .....	30	Seat belt nonusage warning system .....	56	Cassette player .....	100
Doors .....	31	BabySmart™ airbag deactivation system .....	62	Telephone .....	101
Central locking switch .....	33	Supplemental Restraint System (SRS) .....	63	Navigation system .....	106
Automatic central locking .....	34	Emergency tensioning retractor (ETR) .....	64	Trip computer .....	107
Emergency unlocking in case of accident .....	34	Airbags .....	65	Malfunction/warning message memory .....	109
Trunk .....	35	Safety guidelines for the seat belt, emergency tensioning retractor and airbag .....	72	Individual settings .....	111
Trunk lid release switch .....	37			Setting the audio volume .....	123

Coolant temperature gauge .....	124	Rear passenger compartment adjustable air outlets .....	159	Storage compartments and armrests .....	193
Flexible service system (FSS) .....	125	Operation Audio and telephone ...	160	Glove box .....	194
Engine oil level indicator .....	128	Operating safety .....	160	Cup holder .....	197
Engine oil consumption .....	129	Operating and display elements .....	161	Ashtrays .....	199
Exterior lamp switch .....	130	Button and soft key operation .....	163	Lighter .....	201
Headlamp mode .....	131	Operation .....	163	Parcel net in front passenger footwell .....	202
Night security illumination .....	132	Power windows .....	184	Ski sack .....	202
Locator lighting .....	133	Sliding/pop-up roof .....	187	Enlarged cargo area .....	207
Headlamp cleaning system .....	133	Interior lighting .....	189	Split folding rear seat bench .....	207
Combination switch .....	134	Rear window sunshade .....	191	Loading instructions (vehicle with enlarged cargo area) .....	209
Hazard warning flasher switch .....	137	Sun visors .....	192	Cellular telephone .....	210
Climate control .....	138	Vanity mirrors .....	192	Telephone, general .....	211
Automatic climate control .....	146	Interior .....	193	Garage door opener .....	212
Front center console storage compartment ventilation .....	158				

## Central locking system

22

**Vehicle keys**

Included with your vehicle are 2 electronic main keys with integrated radio frequency and infrared remote controls plus removable mechanical key.

The locking tabs for the mechanical key portion of the two electronic main keys are a different color to help distinguish it.

**Warning!**

**When leaving the vehicle always remove the electronic key from the starter switch, and lock your vehicle. Do not leave children unattended in the vehicle, or with access to an unlocked vehicle. Unsupervised use of vehicle equipment may cause serious personal injury.**

## Electronic main key

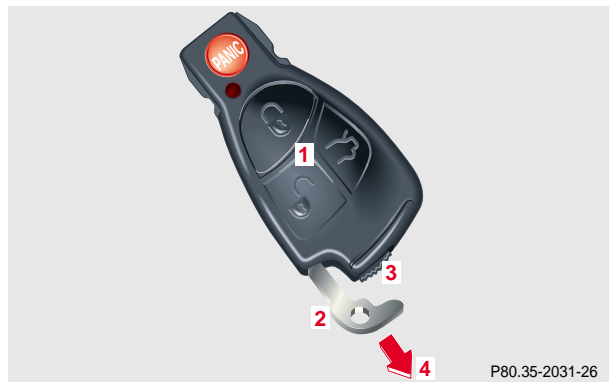

The electronic main key has an integrated radio frequency and infrared remote control, plus removable mechanical key.

The remote control (1) operates all locks on the vehicle.

The mechanical key (2) works only in the driver's door, trunk, and storage compartment locks.

When using the mechanical key (2) for lock operations, it can be removed by sliding it out of the remote control. To do so, move locking tab (3) to the right and slide the mechanical key (2) in direction of arrow (4).

The remote control transmitter is located in the electronic main key.

The infrared receivers are located in the front door handles.

Note:

Remove the mechanical key from the electronic main key when using valet parking service. To prevent access to trunk or storage compartments lock them separately and retain the mechanical key.

See page 35 for separate locking of trunk and page 194 for locking of glove box.

### Obtaining replacement keys

Your vehicle is equipped with a theft deterrent locking system requiring a special key manufacturing process. For security reasons, replacement keys can only be obtained from your authorized Mercedes-Benz Center.

## Central locking system

24

**Start lock-out****Important!**

Removing the electronic key from the starter switch activates the start lock-out. The engine cannot be started.

Inserting the electronic key in the starter switch deactivates the start lock-out.

**Note:**

In case the engine cannot be started (vehicle's battery is in order), the system is not operational. Contact an authorized Mercedes-Benz Center or call 1-800-FOR-MERCEdes (in the USA), or 1-800-387-0100 (in Canada).

**General notes on the central locking system**



- If the electronic key is inserted in the starter switch, the vehicle cannot be locked or unlocked with the remote control.

If the vehicle cannot be locked or unlocked:

- Aim transmitter eye at a receiver of either front door handle. Check the batteries of the electronic main key, see page 332, or synchronize the electronic main key, see page 334.
- Use the mechanical key to unlock the vehicle. To start engine, insert the electronic key in the starter switch. There could be a slight delay until the electronic key can be turned in the starter switch.

**Important!**

When unlocking the driver's door with the mechanical key, the exterior lamps will flash and the alarm will sound.

To cancel the alarm, insert the electronic key in the starter switch or press button  or  on the electronic main key.



## Central locking system

### Radio frequency and infrared remote control

The electronic main key has an integrated radio frequency and infrared remote control.

Due to the extended operational range of the remote control, it could be possible to unintentionally lock or unlock the vehicle by pressing the transmit button. If one of the transmit buttons is pressed, the battery check lamp lights up briefly – indicating that the batteries are in order. See page 332 for checking batteries.

The vehicle doors, trunk and fuel filler flap can be centrally locked and unlocked via remote control.

Opening and closing the windows and sliding/pop-up roof can only be done with the infrared portion of the remote control. Aim transmitter eye at a receiver (6 or 7), press and hold transmit button  or , see page 29.

With vehicle centrally locked, the trunk can also be opened by using the remote control.

If the electronic key is inserted in starter switch, the vehicle cannot be locked or unlocked, and the trunk lid cannot be opened with the remote control.



#### 1 Transmit button



Locking



Unlocking



Opening trunk (if not separately locked)

#### 2 Lamp for battery check (see page 332 for changing batteries if it does not light up briefly)

#### 3 PANIC button

#### 4 Transmitter eye

#### 5 Locking tab for mechanical key

## Central locking system

26



6 Infrared receiver in driver's door handle

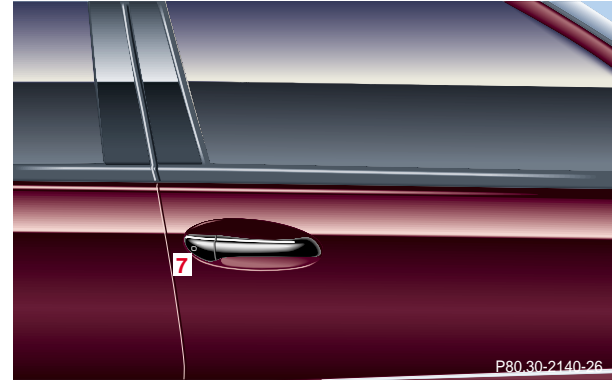

7 Infrared receiver in front passenger door handle

## Locking and unlocking with remote control

Unlocking:

Press transmit button . All turn signal lamps blink once to indicate that the vehicle is unlocked.

The remote control can be programmed for two kinds of unlocking modes (see below):

Selective unlocking mode –

Press transmit button  once to unlock driver's door and fuel filler flap.

Press transmit button  twice to unlock all doors, fuel filler flap, and trunk.

Global unlocking mode –

Press transmit button  once to unlock all doors, fuel filler flap, and trunk.

Notes:

If the trunk was previously locked separately, it will remain locked, see page 35.

The presently active unlocking mode (selective or global) can only be determined by unlocking the vehicle with the remote control (see below for changing mode).

If within 40 seconds of unlocking with the remote control, neither door or trunk is opened, the electronic key is not inserted in the starter switch, or the central locking switch is not activated, the vehicle will automatically lock.



Locking:

Press transmit button  once. All turn signal lamps blink three times to indicate that the vehicle is locked. If they do not blink three times, a door or trunk is not properly closed.

Note:

If the vehicle cannot be locked or unlocked by pressing the transmit button, then it may be necessary to change the batteries in the electronic main key (if ok, battery check lamp in electronic main key will light briefly when pressing transmit button) or to synchronize the remote control, see pages 332 and 334.

### Choosing global or selective mode on remote control

Press and hold transmit buttons  and  simultaneously for five seconds to reprogram the remote control. Battery check lamp will blink two times indicating the completed mode change.



## Central locking system

28

**Opening the trunk**

The trunk lid will swing open automatically. You should always make sure there is sufficient clearance.

A minimum height clearance of 5.75 ft. (1.75 m) is required to open the trunk lid.

Press transmit button  until trunk lid is open.

**Important!**

Do not place remote control in trunk since trunk is locked when the lid is closed if the vehicle is centrally locked.

Notes:

If the trunk was previously locked separately, it will remain locked, see page 35.

### Opening and closing windows and sliding/pop-up roof from outside (summer opening/convenience feature)

Aim transmitter eye of remote control at the door receiver.

#### Summer opening:

The sliding/pop-up roof and all side windows can be opened automatically.

Continue to press transmit button  after unlocking the vehicle.

The windows and sliding/pop-up roof begin to open after approximately 1 second.

To interrupt opening procedure, release transmit button.

#### Convenience feature:

The sliding/pop-up roof and the side windows can be closed.

Continue to press transmit button  after locking the vehicle.



The windows and sliding/pop-up roof begin to close after approximately 1 second.

To interrupt closing procedure, release transmit button.

Ensure that all side windows and the sliding/pop-up roof are properly closed before leaving the vehicle.

#### Warning!

**Never operate the windows or sliding/pop-up roof if there is the possibility of anyone being harmed by the opening or closing procedure.**

**In case the procedure causes potential danger, the procedure can be immediately halted by releasing the remote control button. To reverse direction of movement press  for opening or  for closing.**

Note:

If the windows and sliding/pop-up roof cannot be operated automatically by pressing the transmit button of the remote control then it may be necessary to change the batteries in the electronic main key (if ok, battery check lamp in electronic main key will light briefly when transmitting), or to synchronize the remote control, see page 332 and 334.

## Central locking system

30

## Panic button



To activate press and hold button (1) for at least one second. An audible alarm and blinking exterior lamps will operate for approximately 3 minutes.

To deactivate press button (1) again, or insert electronic key in starter switch.

Note:

For operation in the USA only: This device complies with Part 15 of the FCC Rules. Operation is subject to the following two conditions:

- (1) This device may not cause harmful interference, and
- (2) this device must accept any interference received, including interference that may cause undesired operation.

Any unauthorized modification to this device could void the user's authority to operate the equipment.

## Mechanical keys

The mechanical keys work only in driver's door, trunk, and storage compartment locks.

Notes:

The mechanical key does not operate the central locking system or antitheft alarm system.

The fuel filler flap cannot be locked or unlocked with the mechanical key.

If the fuel filler flap cannot be opened, see page 335.

## Doors

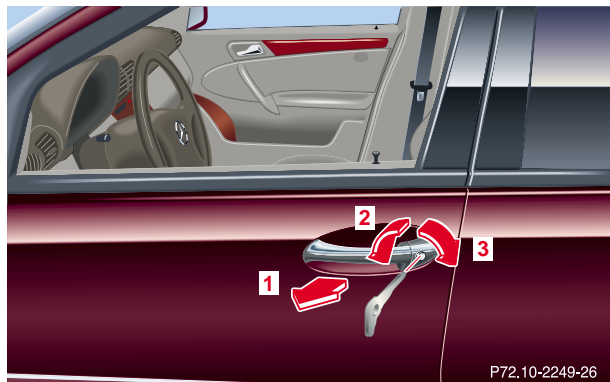

- 1 Opening – pull handle
- 2 Unlocking driver's door
- 3 Locking driver's door

### Important!

The mechanical key does not operate the central locking system or anti-theft alarm system.

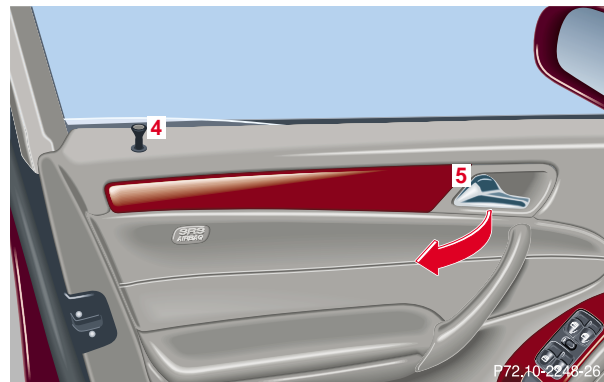

- 4 Individual door from inside:  
Push lock button down to lock.
- 5 Front door from inside:  
Pull handle to unlock.

When you lock the driver's door with the mechanical key, the door lock button should move down.

Each individual door must be locked with the respective door lock button – the driver's door can only be locked when it is closed.

## Central locking system

32

If the vehicle has previously been locked from the outside, opening a door from the inside will trigger the alarm. When opening a front door while the central locking system is in the:

- selective unlocking mode, only that individual door is unlocked. The remaining doors, the trunk and fuel filler flap remain locked.
- global unlocking mode, all doors, the trunk and fuel filler flap are unlocked.

Notes:



In case of a malfunction in the central locking system the doors can be locked and unlocked individually.

To lock, push down lock buttons or turn mechanical key in driver's door lock to position 3. In addition lock the trunk.

To unlock, pull inside door handles or turn mechanical key in driver's door lock to position 2.

Rear doors can only be opened from inside by first pulling up the door lock button.

When unlocking the driver's door with the mechanical key, the exterior lamps will flash and the alarm will sound.

To cancel the alarm, insert the electronic key in the starter switch or press button  or  on the electronic main key.

## Central locking switch

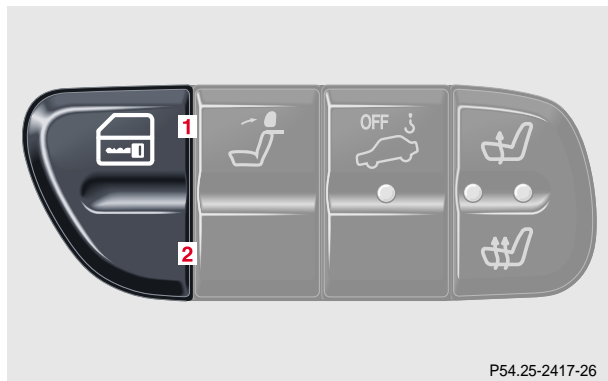

- 1 Locking
- 2 Unlocking

The central locking switch is located in the center console.

The doors and trunk can only be locked with the central locking switch, if both front doors are closed.



If the vehicle was previously locked with the central locking switch, while in the selective remote control mode, only the door opened from the inside is unlocked.

If the vehicle was previously locked with the central locking switch, while in the global remote control mode, the complete vehicle is unlocked when a door is opened from the inside.

Notes:

If the vehicle was previously locked with the remote control, the doors and trunk cannot be unlocked with the central locking switch.

The fuel filler flap cannot be locked or unlocked with the central locking switch.

If the vehicle has previously been locked from the outside, opening a door from the inside will trigger the alarm. To cancel the alarm, insert the electronic key in the starter switch or press button  or  on the electronic main key.

### Warning!

**When leaving the vehicle always remove the electronic key from the starter switch, and lock your vehicle. Do not leave children unattended in the vehicle, or with access to an unlocked vehicle. Unsupervised use of vehicle equipment may cause serious personal injury.**

## Central locking system

34

**Automatic central locking**

With the automatic central locking system activated, the doors and trunk are locked at vehicle speeds of approximately 9 mph (15 km/h) or more. The fuel filler flap remains unlocked.

The automatic central locking function can be switched on or off. See page 111 for “Individual settings”.

Notes:

If doors are unlocked with the central locking switch after activating the automatic central locking, and neither door is opened, then the doors remain unlocked even at vehicle speeds of approximately 9 mph (15 km/h) or more.

If a door is opened from the inside at speeds of approximately 9 mph (15 km/h) or less with the automatic central locking activated, the door will again be automatically locked at speeds of approximately 9 mph (15 km/h) or more.

**Important!**

When towing the vehicle, or with the vehicle on a dynamometer test stand, please, note the following:

With the automatic central locking activated and the electronic key in starter switch position 2, the vehicle doors will lock if the left front wheel as well as the right rear wheel spin at vehicle speeds of approximately 9 mph (15 km/h) or more.

To prevent the vehicle door locks from locking, deactivate the automatic central locking. See page 111 for “Individual settings” - “VEHICLE”.

**Emergency unlocking in case of accident**

The doors unlock automatically a short time after an accident in which an airbag or emergency tensioning retractor deploys (this is intended to aid rescue and exit).

## Trunk

The lock is located next to the recessed handle.

When the trunk is separately locked, it remains locked when centrally unlocking the vehicle.

To deny any unauthorized person access to the trunk, lock it separately with the mechanical key. Leave only the electronic main key less its mechanical key with the vehicle.



Notes:

In case of a malfunction in the central locking system the trunk can be unlocked individually.

To unlock and open the trunk lid, turn mechanical key to position 2, hold and push to open.

The mechanical key does not operate the central locking system or antitheft alarm system.

When unlocking the trunk with the mechanical key, the exterior lamps will flash and the alarm will sound.

To cancel the alarm, insert the electronic key in the starter switch or press button  or  on the electronic main key.

If the fuel filler flap cannot be opened, see page 335.

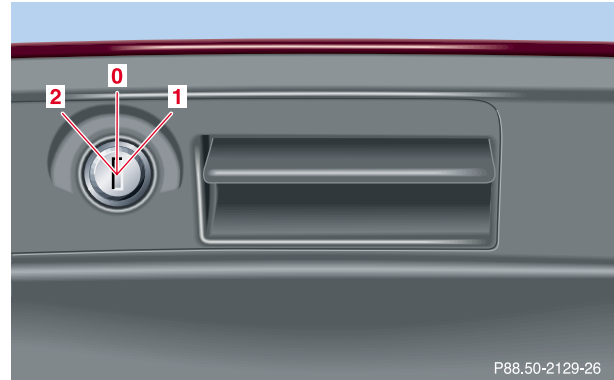

**0** Neutral position

**1** Separate locking of trunk – remove mechanical key in this position.

**2** Unlocking

### Important!

Do not place mechanical key inside trunk, since trunk is locked again when closing the lid if the vehicle has been previously centrally locked.



## Central locking system

36

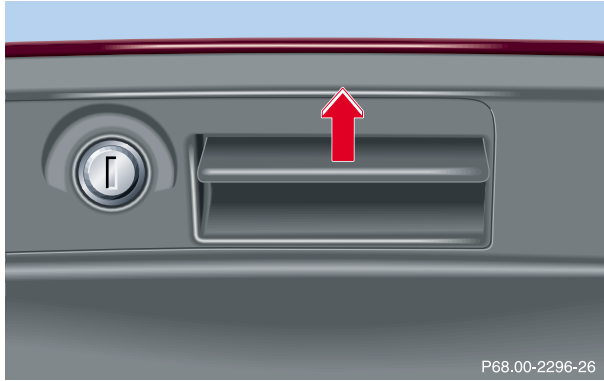

Pull handle (arrow) to open the trunk lid.

The trunk lid will swing open automatically. You should always make sure there is sufficient clearance.

A minimum height clearance of 5.75 ft. (1.75 m) is required to open the trunk lid.

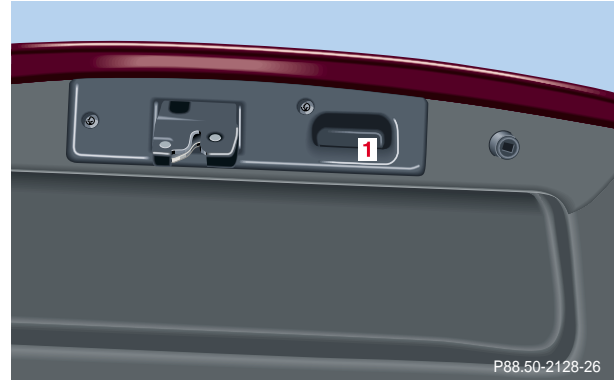

Lower trunk lid using handle (1) and close it with hands placed flat on trunk lid. Please remember to keep your fingers out of the space between the lid and the vehicle.

## Trunk lid release switch

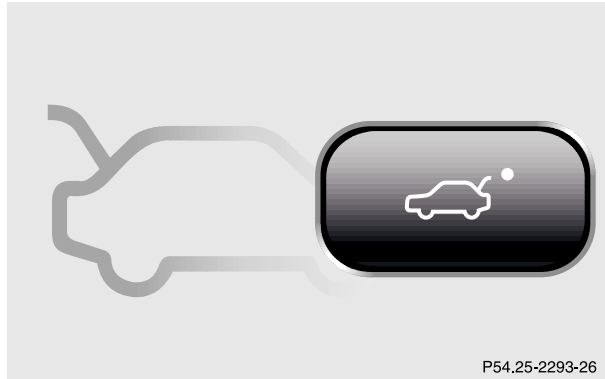

The switch is located on the driver's door.

The trunk lid will swing open automatically. You should always make sure there is sufficient clearance.

A minimum height clearance of 5.75 ft. (1.75 m) is required to open the trunk lid.

To open the trunk, the vehicle must be at standstill. Press switch until trunk lid is open.

The indicator lamp in the switch remains on with trunk lid open.

Notes:

The trunk can also be opened by using the remote control. Press  button.

The trunk lid cannot be opened by the switch or the remote control when previously locked separately with the mechanical key. To open, see page 35.

The trunk lid cannot be opened with the trunk lid release switch when the vehicle was previously locked with the remote control. To unlock vehicle with the remote control, see page 25.

## Antitheft alarm system

## Antitheft alarm system

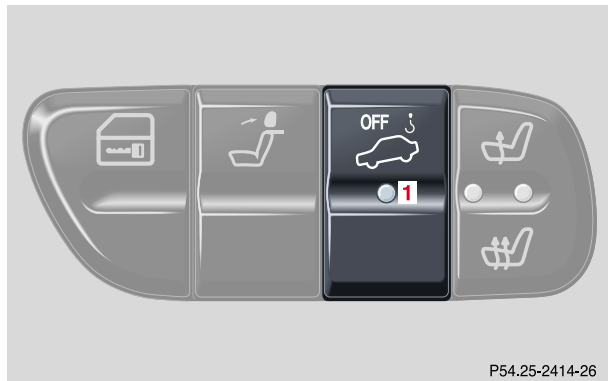

**1** Indicator lamp in switch located in center console

The antitheft alarm is automatically armed or disarmed with the remote control by locking or unlocking the vehicle.

The antitheft alarm is armed within approximately 10 seconds after locking the vehicle.

A blinking lamp (1) indicates that the alarm is armed.

## 38

Operation:



Once the alarm system has been armed, the exterior vehicle lamps will flash and an alarm will sound when someone:

- opens a door,
- opens the trunk,
- opens the hood,
- attempts to raise the vehicle.

The alarm will last approximately 3 minutes in form of flashing exterior lamps. At the same time an alarm will sound for 30 seconds. The alarm will stay on even if the activating element (a door, for example) is immediately closed. If the alarm stays on for more than 20 seconds, an emergency call is initiated automatically. See Tele Aid on page 220.

Notes:

When you unlock the driver's door with the mechanical key, the exterior lamps will flash and the alarm will sound.

To cancel the alarm, insert the electronic key in the starter switch or press button  or  on the electronic main key.

## Tow-away alarm

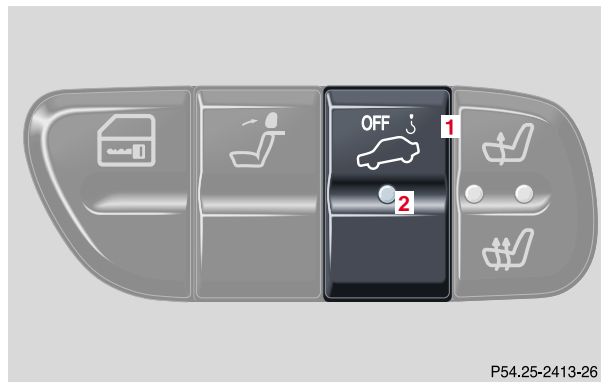



The switch is located in the center console.

- 1 Press to switch off tow-away alarm
- 2 Indicator lamp

Once the alarm system has been armed, the exterior vehicle lamps will flash and an alarm will sound when someone attempts to raise the vehicle.

## Tow-away alarm

40

The alarm will last approximately 3 minutes in form of flashing exterior lamps. At the same time an alarm will sound for 30 seconds. The alarm will stay on even if the vehicle is immediately lowered. To cancel the alarm, insert the electronic key in the starter switch or press button  or  on the electronic main key.

If the alarm stays on for more than 20 seconds, an emergency call is initiated automatically. See Tele Aid on page 220.

To prevent triggering the tow-away alarm feature, switch off the tow-away alarm before towing the vehicle, or when parking on a surface subject to movement, such as a ferry or auto train.

To do so, turn electronic key in starter switch to position 1 or 0, or remove electronic key from starter switch. Press tow-away alarm switch (1). The indicator lamp (2) illuminates briefly.

Exit vehicle, and lock vehicle with the electronic main key.

The tow-away alarm remains switched off until the vehicle is locked again with the electronic main key, at which time it is automatically reactivated.

## Easy-entry/exit feature

With the easy-entry/exit feature activated, the steering wheel tilts upwards and the driver's seat moves rearwards.

This allows easier entry into and exit from the vehicle when the driver's door is opened. However, the engine must be turned off.

See page 121 for activating/deactivating the easy-entry/exit feature.

When the electronic key is inserted in the starter switch and the driver's door is closed, the steering wheel and the driver's seat return to the last position set for it.

### Warning!

**You must ensure that no one can become trapped or injured by the moving steering wheel and the driver's seat with the easy-entry/exit feature activated and you open the driver's door or remove the electronic key from the starter switch. Do not leave children unattended in the vehicle, or with access to an unlocked vehicle. Unsupervised use of vehicle equipment may cause serious personal injury.**

## Front seat adjustment

### Warning!

Do not adjust the driver's seat while driving. Adjusting the seat while driving could cause the driver to lose control of the vehicle.

Never ride in a moving vehicle with the seat back reclined. Sitting in an excessively reclined position can be dangerous. You could slide under the seat belt in a collision. If you slide under it, the belt would apply force at the abdomen or neck. That could cause serious or fatal injuries. The seat back and seat belts provide the best restraint when the wearer is in an upright position and belts are properly positioned on the body.

Never place hands under seat or near any moving parts while a seat is being adjusted.

When leaving the vehicle always remove the electronic key from the starter switch, and lock your vehicle.

The power seats can also be operated with the driver's or front passenger door open. Do not leave children unattended in the vehicle, or with access to an unlocked vehicle. Unsupervised use of vehicle equipment may cause serious personal injury.

To operate the front power seat adjustment switches, turn the electronic key in starter switch to position 1 or 2 (with a front door open, the power seats can also be operated with the electronic key removed or in starter switch position 0).

## Power seat

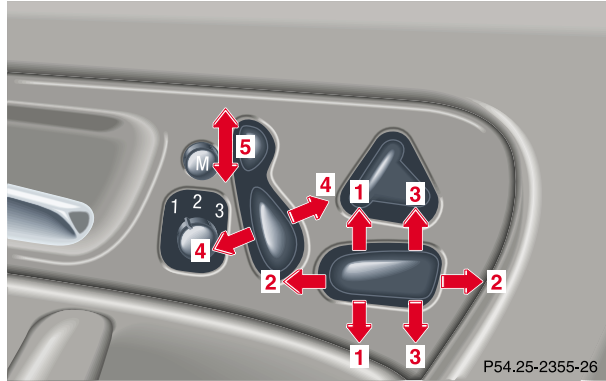

The switches are located in each front door.

We recommend to adjust the power seat in the following order:

### 1 Seat, up/down

Press the switch (up/down direction) until comfortable seating position with still sufficient headroom is reached.

### 2 Seat adjustment, fore/aft

Press the switch (fore/aft direction) until a comfortable seating position is reached that still allows you to reach the accelerator/brake pedal safely. The position should be as far rearward as possible, consistent with ability to properly operate controls.

### 3 Seat cushion tilt

Press the switch in the direction of the arrow until your legs are lightly supported.

### 4 Backrest tilt

Press the switch in the direction of the arrow until your arms are slightly angled when holding the steering wheel.



### 5 Head restraint

The height of the head restraint is adjusted automatically with the seat so that the back of the head is supported approximately at ear level. Adjust the head restraint using the switch to support the back of your head approximately at ear level.

Only minor personal adjustments, as described below, should then be required.

For exterior rear view mirrors, see page 81;  
inside rear view mirror, see page 80;  
steering wheel adjustment, see page 79.

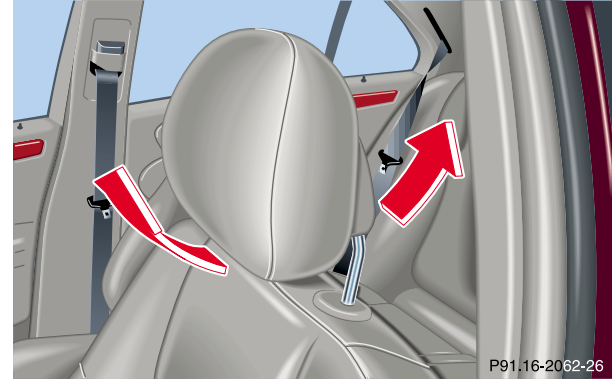

Adjust the head restraint angle by hand. Push or pull the head restraint in direction of arrow.

Storing seat positions:

The head restraint, steering wheel and exterior rear view mirror position are stored together with the seat position.

See page 85 for notes on the memory function. For recalling a stored seat/head restraint/steering wheel/and exterior rear view mirror position see page 86.

## Manual seat

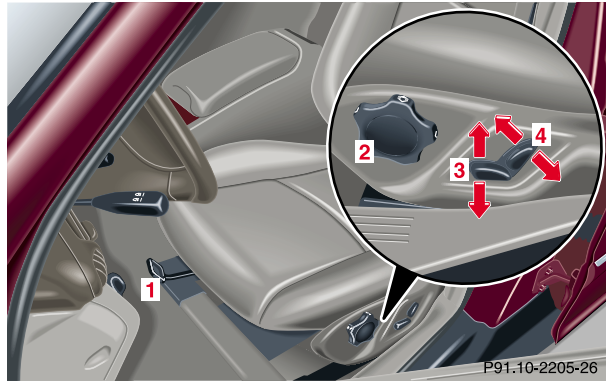

(Standard equipment on Model C 240)

We recommend to adjust the seat in the following order:

### 1 Fore/aft adjustment

Lift handle (1), slide seat to desired position and allow handle to reengage. Check for proper engagement before driving.

### 2 Seat cushion tilt

Turn handwheel (2) forward or backward.

### 3 Seat height adjustment

Press the switch (3) in the direction of the arrow until your legs are lightly supported.

### 4 Backrest tilt

Press the switch (4) in the direction of the arrow until your arms are slightly angled when holding the steering wheel.

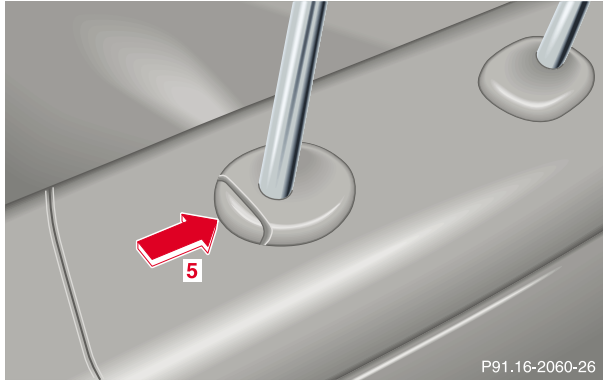

### 5 Head restraint height

Raising:

Pull up on head restraint.

Lowering:

Push button (5) and push down on head restraint.

Adjust head restraint to support the back of the head approximately at ear level. The head restraint inclination can also be adjusted manually.

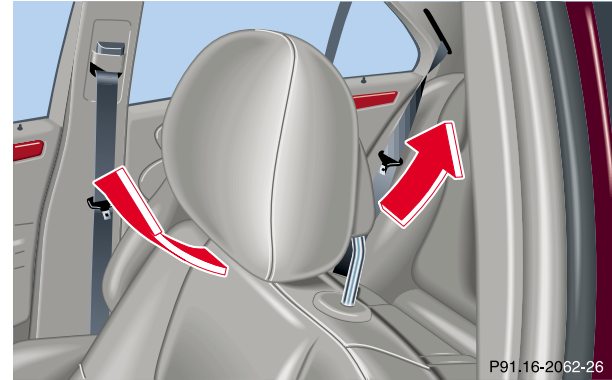

### Head restraint inclination

Push or pull the head restraint in direction of arrow.

## Removal and installation of front seat head restraints

### Power seat

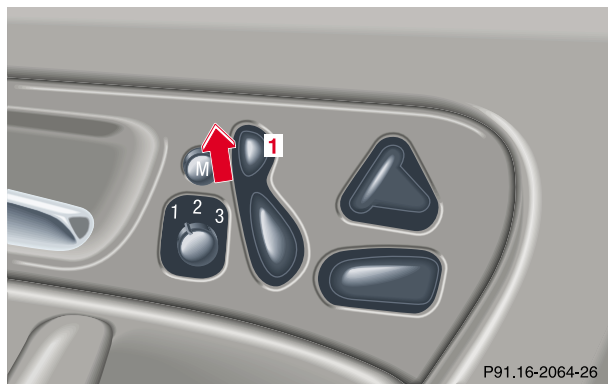

### Caution!

Do not remove head restraints except when mounting seat covers. Whenever restraints have been removed be sure to reinstall them before driving.

Note:

Tilt the backrest rearward for easier removal and installation of the head restraints.

To remove:

Press switch (1) upwards and hold until the head restraint is fully extended. Pull head restraint out.

To install:

Press switch (1) upwards and hold for about 5 seconds.

Press the head restraint down until it engages.

Adjust head restraint to the desired position.

### Warning!

**For your protection, drive only with properly positioned head restraints.**

**Adjust head restraint to support the back of the head approximately at ear level.**

**Do not drive the vehicle without the seat head restraints. Head restraints are intended to help reduce injuries during an accident.**

### Manual seat

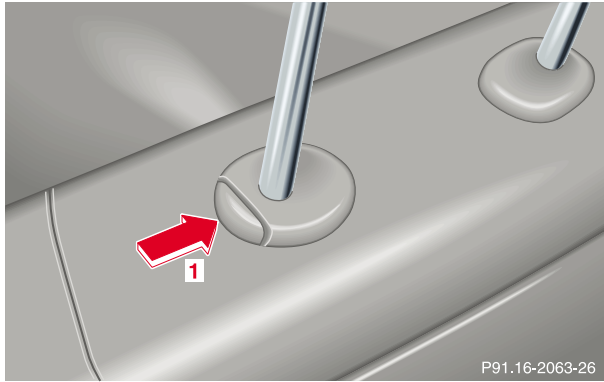

To remove:

Pull head restraint to its highest position. Push button (1) and pull out head restraint completely.

To install:

Insert head restraint and push it down to the stop. Push button (1) and adjust head restraint to the desired position.

### Warning!

For your protection, drive only with properly positioned head restraints.

Adjust head restraint to support the back of the head approximately at ear level.

Do not drive the vehicle without the seat head restraints. Head restraints are intended to help reduce injuries during an accident.

## Multicontour seat (optional)

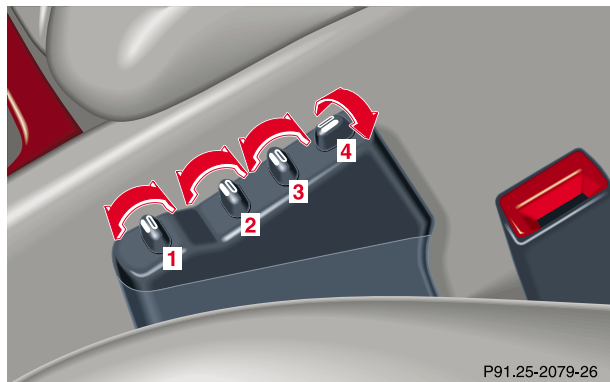

We recommend to adjust the multicontour seat in the following order:

- 1 Seat cushion depth
- 2 Backrest bottom
- 3 Backrest center
- 4 Side bolster adjustment

Some models may be equipped with driver's multicontour seat. These seats have movable seat cushions and inflatable air cushions built into the backrest to provide additional lumbar and side support.

The seat cushion movement and amount of backrest cushion height and curvature can be continuously varied with regulators (1, 2 and 3) after turning the electronic key in starter switch to position 2.

The side bolsters of the backrest can be adjusted with rocker switch (4):

- press to the left – increase side support,
- press to the right – decrease side support.

If the engine is turned off, the last cushion setting is retained in memory, and automatically adjusts the cushion to this setting when the engine is restarted.

## Seats

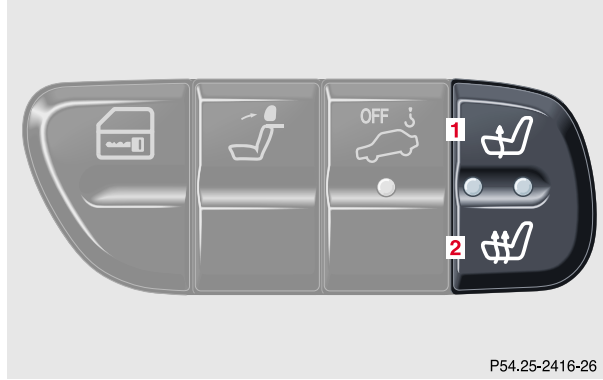
**Heated seats (optional)**

The front seat heaters can be switched on with the electronic key in starter switch position 1 or 2.

The switch is located in the center console.

## 50

Press switch to turn on seat heater:

- 1** Normal seat heating mode. One indicator lamp in the switch lights up.
- 2** Rapid seat heating mode. Both indicator lamps in the switch light up. After approximately 5 minutes in the rapid seat heating mode, the seat heater automatically switches to normal operation and only one indicator lamp will stay on.

Turning off seat heater:

If one indicator lamp is on, press upper half of switch.

If both indicator lamps are on, press lower half of switch.

If left on, the seat heater automatically turns off after approximately 30 minutes of operation.

Note:

When in operation, the seat heater consumes a large amount of electrical power. It is not advisable to use the seat heater longer than necessary.

The seat heaters may automatically switch off if too many power consumers are switched on at the same time, or if the battery charge is low. When this occurs, the indicator lamp in the switch will blink (both indicator lamps blink during rapid seat heating mode). The seat heaters will switch on again automatically as soon as sufficient voltage is available.

If the blinking of the indicator lamps is distracting to you, the seat heaters can be switched off.



## Rear seat head restraints

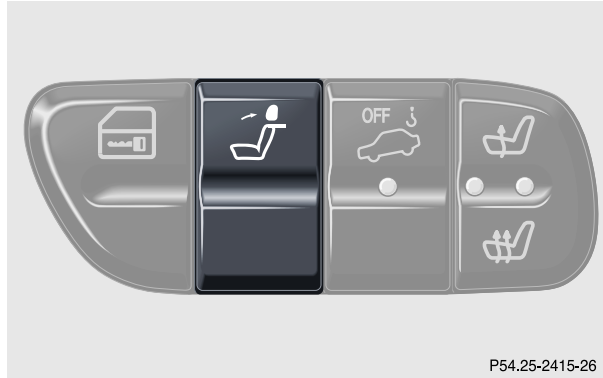

Folding head restraints back with switch in the center console:

Turn the electronic key in starter switch to position 1 or 2.

Folding head restraints back:

Press the symbol-side on the rocker switch to release the head restraints. The head restraints will fold backward for increased visibility.

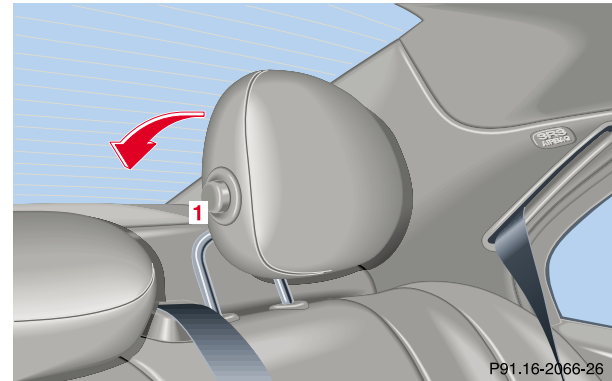

Folding head restraints back in the rear passenger compartment:

Push lock button (1). The head restraints will fold backward.

## Place head restraints upright

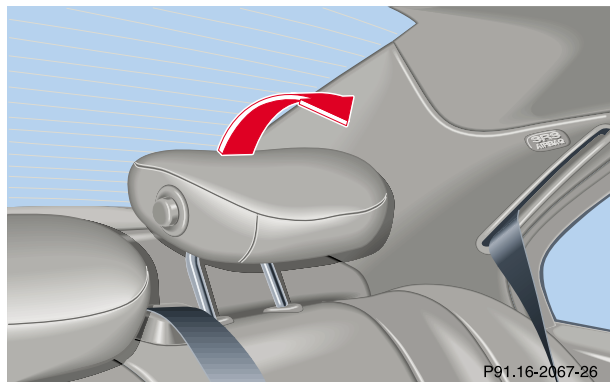

Placing head restraints upright:

Pull the head restraint forward until it locks into position.

Angle of head restraints:

The head restraint angle can be adjusted manually.

## Important!

For safety reasons, always drive with the rear head restraints in the upright position when the rear seats are occupied.

Keep the area around head restraints clear of articles (e.g. clothing) to not obstruct the folding operation of the head restraints.

## Seats

54

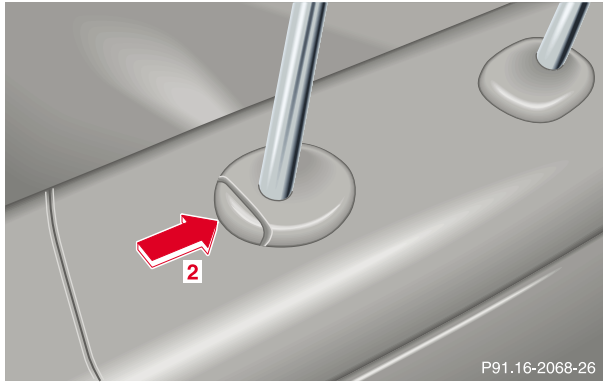
**Head restraint height****Raising:**

Pull up on head restraint.

**Lowering:**

Push button (2) and push down on head restraint.

Adjust head restraint to support the back of the head approximately at ear level. The head restraint inclination can also be adjusted manually.

**Note:**

The center rear seat head restraint cannot be adjusted or removed.

## Seat belts and integrated restraint system

Your vehicle is equipped with seat belts for all seats, emergency tensioning retractors for all outboard seat belts, dual front airbags, door mounted side impact airbags, and head protective window curtain airbags. Their protective functions are designed to complement one another.

## Seat belts

### Important!

Laws in most states and all Canadian provinces require seat belt use.

All states and provinces require use of child restraints that comply with U.S. Federal Motor Vehicle Safety Standard 213 and Canadian Motor Vehicle Safety Standard 213.

All child restraints systems are designed to be secured in vehicle seats by lap belts or the lap belt portion of a lap-shoulder belt.

For your safety and that of your passengers we strongly recommend their use.

### Warning!

**Children 12 years old and under must never ride in the front seat, except in a Mercedes-Benz authorized BabySmart™ compatible child seat, which operates with the BabySmart™ system installed in the vehicle to deactivate the passenger side front airbag when it is properly installed. Otherwise they will be struck by the airbag when it inflates in a crash. If this happens, serious or fatal injury will result.**

According to accident statistics, children are safer when properly restrained in the rear seating positions than in the front seating positions. Infants and small children must ride in back seats and be seated in an appropriate infant or child restraint system, which is properly secured with the vehicle's seat belt, fully in accordance with the child seat manufacturer's instructions.

A child's risk of serious or fatal injuries is significantly increased if the child restraints are not properly secured in the vehicle and the child is not properly secured in the child restraint.

**Warning!**

**Never ride in a moving vehicle with the backrest reclined. Sitting in an excessively reclined position can be dangerous. You could slide under the seat belt in a collision. If you slide under it, the belt would apply force at the abdomen or neck. That could cause serious or even fatal injuries. The backrest and seat belt provide the best restraint when the wearer is in an upright position and the belt is properly positioned on the body.**

**Seat belt nonusage warning system**

With the electronic key in starter switch position 2, a warning sounds for a short time if the driver's seat belt is not fastened.

Automatic comfort-fit seat belt:

An automatic comfort-fit feature for driver and front passenger seat belt is activated when the electronic key in the starter switch is turned to position 1 or 2.

The retraction force of the inertia reel is reduced, increasing the level of seat belt comfort.

Note:

For cleaning and care of the seat belts see page 345.

### **Warning!**

**Failure to wear and properly fasten and position your seat belt greatly increases your risk of injuries and their likely severity in an accident. You and your passengers should always wear seat belts.**

**If you are ever in an accident, your injuries can be considerably more severe without your seat belt properly buckled. Without your seat belt buckled, you are much more likely to hit the interior of the vehicle or be ejected from it. You can be seriously injured or killed.**

**In the same crash, the possibility of injury or death is lessened if you are wearing your seat belt.**

### **Warning!**

**Never let more people ride in the vehicle than there are seat belts available. Be sure everyone riding in the vehicle is correctly restrained with a separate seat belt.**

## Restraint systems

58

## Fastening seat belts

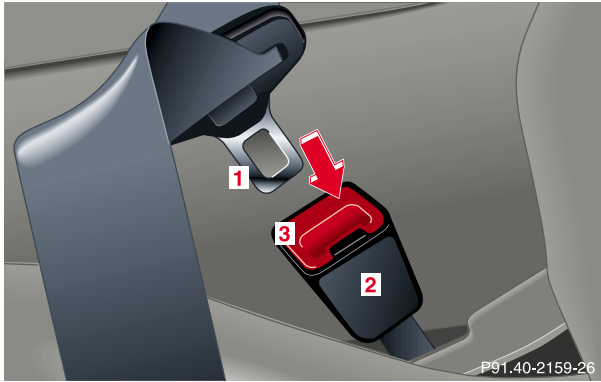

- 1 Latch plate
- 2 Buckle
- 3 Release button

Push latch plate (1) into buckle (2) until it clicks. Do not twist the belt. A twisted seat belt may cause injury.

The lap belt should be positioned as low as possible on your hips and not across the abdomen.

**Warning!**

**Always fasten your seat belt before driving off. Always make sure your passengers are properly restrained – even those sitting in the rear.**

Tighten the lap portion to a snug fit by pulling shoulder portion up.

The shoulder portion of the seat belt must be pulled snug and checked for snugness immediately after engaging it.

Adjust seat belt so that shoulder portion is located as close as possible to the middle of your shoulder (it should not touch the neck). For this purpose, you can adjust the height of the belt outlet.

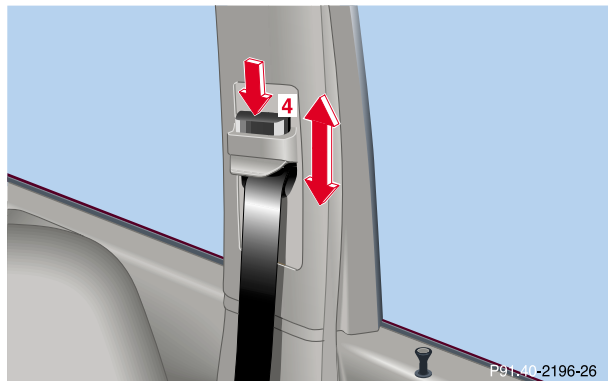

#### 4 Button for belt outlet height adjustment

To raise, slide belt outlet upward.

To lower, press button (4) and slide belt outlet downward.

### Operation of seat belts

The inertia reel stops the belt from unwinding during sudden stops or when quickly pulling on the belt.

The locking function of the reel may be checked by quickly pulling out the belt.

Adjust seat belt so that shoulder portion is located as close as possible to the middle of your shoulder (it should not touch the neck).

### Caution!

For safety reasons, avoid adjusting the seat or seat back into positions which could affect the correct seat belt positioning.

### Unfastening of seat belts

Press release button (3) in the belt buckle (2).

Allow the retractor to completely rewind the seat belt by guiding the latch plate (1).



**Warning!****USE SEAT BELTS PROPERLY.**

- Seat belts can only work when used properly. Never wear seat belts in any other way than as described in this section, as that could result in serious injuries in case of an accident.
- Each occupant should wear their seat belt at all times, because seat belts help reduce the likelihood of and potential severity of injuries in accidents, including rollovers. The integrated restraint system includes “SRS” (driver airbag, front passenger airbag, side impact airbags, head protection window curtain airbags for side windows), “ETR” (seat belt emergency tensioning retractors), and front seat knee bolsters. The system is designed to enhance the protection offered to properly belted occupants in certain frontal (front airbags) and side (side impact and window curtain airbags) impacts which exceed preset deployment thresholds.

- Never wear the shoulder belt under your arm, against your neck or off your shoulder. In a crash, your body would move too far forward. That would increase the chance of head and neck injuries. The belt would also apply too much force to the ribs or abdomen, which could severely injure internal organs such as your liver or spleen.
- Never wear belts over rigid or breakable objects in or on your clothing, such as eyeglasses, pens, keys etc., as these might cause injuries.
- Position the lap belt as low as possible on your hips and not across the abdomen. If the belt is positioned across your abdomen, it could cause serious injuries in a crash.
- Each seat belt should never be used for more than one person at a time. Do not fasten a seat belt around a person and another person or other objects.
- Belts should not be worn twisted. In a crash, you wouldn't have the full width of the belt to manage impact forces. The twisted belt against your body could cause injuries.

- Pregnant women should also use a lap-shoulder belt. The lap belt portion should be positioned as low as possible on the hips to avoid any possible pressure on the abdomen.
- Never place your feet on the instrument panel or on the seat. Always keep both feet on the floor in front of the seat.

**Warning!**

**USE CHILD RESTRAINTS PROPERLY.**

Children 12 years old and under must never ride in the front seat, except in a Mercedes-Benz authorized BabySmart™ compatible child seat, which operates with the BabySmart™ system installed in the vehicle to deactivate the passenger front airbag when it is properly installed.

Otherwise they will be struck by the airbag when it inflates in a crash. If this happens, serious or fatal injury will result.

According to accident statistics, children are safer when properly restrained in the rear seating positions than in the front seating positions. Infants and small children must ride in the back seats and be seated in an appropriate infant or child restraint system, which is properly secured with the vehicle's seat belt, fully in accordance with the child seat manufacturer's instructions.

A child's risk of serious or fatal injuries is significantly increased if the child restraints are not properly secured in the vehicle and the child is not properly secured in the child restraint.

Children too big for child restraint systems must ride in back seats using regular seat belts. Position shoulder belt across chest and shoulder, not face or neck. A booster seat may be necessary to achieve proper belt positioning.

### BabySmart™ airbag deactivation system

Special BabySmart™ compatible child seats, designed for use with the Mercedes-Benz system and available at any authorized Mercedes-Benz Center are required for use with the BabySmart™ airbag deactivation system. With the special child seat properly installed, the passenger front airbag will not deploy.

The  indicator lamp located in the center console will be illuminated, except with electronic key removed or in starter switch position 0. The system does not deactivate the door mounted side impact airbag.

### Self-test BabySmart™ without special child seat installed

After turning electronic key in starter switch to position 1 or 2, the  indicator lamp located in the center console comes on for approximately 6 seconds and then extinguishes.

If the indicator lamp should not come on or is continuously lit, the system is not functioning. You must see an authorized Mercedes-Benz Center before seating any child on the front passenger seat. See page 273 for notes on the  indicator lamp.

### Warning!

The BabySmart™ airbag deactivation system will ONLY work with a special child seat designed to operate with it. It will not work with child seats which are not BabySmart™ compatible.

Never place anything between seat cushion and child seat (e.g. pillow), since it reduces the effectiveness of the deactivation system.

Follow the manufacturer's instructions for installation of special child seats.

The passenger front airbag will not deploy only if the  indicator lamp remains illuminated.

Please be sure to check the indicator every time you use the special system child seat. Should the light go out while the restraint is installed, please check installation. If the light remains out, do not use the BabySmart™ restraint to transport children on the front passenger seat until the system has been repaired.

## Supplemental Restraint System (SRS)

Airbags are intended as a supplement to seat belts. Airbags alone cannot protect as well as airbags plus seat belts in impacts for which the airbags were designed to operate, and do not afford any protection whatsoever in crashes for which the airbags are not designed to deploy.

The SRS uses two crash severity levels (thresholds) to activate either the emergency tensioning retractor (ETR) or front airbag or both. Activation depends on the direction and severity of the impact exceeding the preset thresholds and whether the seat belt is fastened.

Seat belt fastened

- first threshold exceeded: ETR activates
- second threshold exceeded: airbag also activates

Seat belt not fastened

Front seats:

- first threshold exceeded: airbag activates, not ETR

Rear outer seats:

- first threshold exceeded: ETR activates

Driver and front passenger and rear outer seat systems operate independently of each other.

## Restraint systems

64

**Emergency tensioning retractor (ETR)**

The seat belts for the front and rear outer seats are equipped with emergency tensioning retractors. These tensioning retractors are located in each belt's inertia reel and become operationally ready with the electronic key in starter switch position 1 or 2.

The emergency tensioning retractors are designed to activate only when the seat belts are fastened during frontal impacts exceeding the first threshold of the SRS and in rear impacts exceeding a preset severity level.

They remove slack from the belts in such a way that the seat belts fit more snugly against the body restricting its forward movement as much as possible.

In cases of other frontal impacts, angled impacts, roll-overs, certain side impacts, or other accidents without sufficient frontal or rear impact forces, the emergency tensioning retractors will not be activated. The driver and passengers will then be protected by the fastened seat belts and inertia reel in the usual manner.

## Airbags

### Front airbags

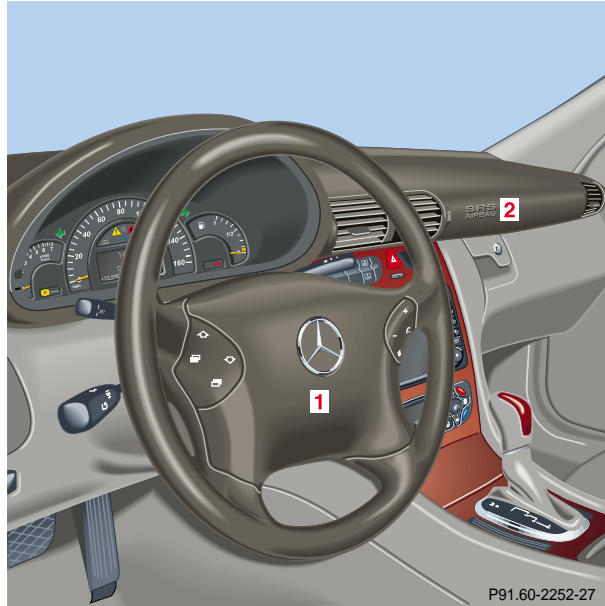

1 Driver airbag

2 Front passenger airbag

The most effective occupant restraint system yet developed for use in production vehicles is the seat belt. In some cases, however, the protective effect of a seat belt can be further enhanced by an airbag.

In conjunction with wearing the seat belts, the driver and front passenger airbags can provide increased protection for the driver and front passenger in certain frontal impacts exceeding preset thresholds.

Side impact and head protection window curtain airbags can provide increased protection to belted occupants on the impacted side of the vehicle in side impacts exceeding its preset threshold.

The operational readiness of the airbag system is verified by the indicator lamp “SRS” in the instrument cluster when turning the electronic key in starter switch to position 1 or 2. If no fault is detected, the lamp will go out after approximately 4 seconds; after the lamp goes out, the system continues to monitor the components and circuitry of the airbag system and will indicate a malfunction by coming on again. If the lamp does not

## Restraint systems

66

come on at all or if it fails to extinguish after approximately 4 seconds or if it comes on thereafter, a malfunction in the system has been detected.

The following system components are monitored or undergo a self-check: crash-sensor(s), airbag ignition circuits, front seat belt buckles, emergency tensioning retractors, seat sensor.

Initially, when the electronic key is turned from starter switch position 0 to position 1 or 2, malfunctions in the crash sensor are detected and indicated (the “SRS” indicator lamp stays on longer than 4 seconds or does not come on).

Have the system checked at your authorized Mercedes-Benz Center immediately

In the operational mode, after the indicator lamp has gone out following the initial check, interruptions or short circuits in the airbag ignition circuit and in the driver and front passenger seat belt buckle harnesses, and low voltage in the entire system are detected and indicated.

**Warning!**

**In the event a malfunction of the “SRS” is indicated as outlined above, the “SRS” may not be operational. For your safety, we strongly recommend that you visit an authorized Mercedes-Benz Center immediately to have the system checked; otherwise the “SRS” may not be activated when needed in an accident, which could result in serious or fatal injury, or it might deploy unexpectedly and unnecessarily which could also result in injury.**

Note:

See page 271 for information on the supplemental restraint system (SRS) indicator lamp.

The driver and passenger front airbags are designed to activate only in certain frontal impacts exceeding a preset threshold. The front passenger airbag deploys only if the front passenger seat is occupied and the  indicator lamp in the center console is not illuminated.

Note:

Heavy objects on the front passenger seat can appear to the “SRS” to indicate the presence of an occupant in that seat which causes the passenger front airbag to deploy in a crash exceeding the appropriate threshold.



## Restraint systems

## Side impact airbags, window curtain airbags

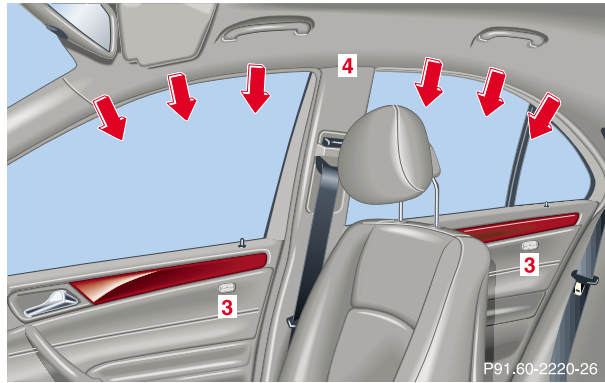

- 3 Side impact airbags
- 4 Window curtain airbags

68

## Side impact airbags

The side impact airbags are designed to activate only in certain side impacts exceeding a preset threshold. Only the side impact airbags on the impacted side of the vehicle deploy.

The side impact airbag for the front passenger deploys only if the front passenger seat is occupied.

Side impact airbags operate best in conjunction with a properly positioned and fastened seat belt.

Note:

Heavy objects on front passenger seat can cause the front passenger side impact airbag to deploy in a crash.

## Window curtain airbag

The head protection window curtain airbags afford greater protection against injuries to the head and upper body. They fill up in the area between the A and C pillars (see arrows) between the side windows and an occupant's head.

The window curtain airbags are designed to activate only in certain side impacts exceeding a preset threshold. Only the head protection window curtain airbag on the impacted side of the vehicle deploys.

### **Important!**

**Airbags are designed to activate only in certain frontal (front airbags) impacts, or side (side impact and head protection window curtain airbags) impacts which exceed preset thresholds.**

**Only during these types of impacts, if of sufficient severity to meet the deployment thresholds, will they provide their supplemental protection.**

**The driver and passenger should always wear their seat belts, otherwise it is not possible for the airbags to provide their supplemental protection.**

**In cases of other frontal impacts, angled impacts, roll-overs, other side impacts, rear collisions, or other accidents, the airbags will not be activated. The driver and passengers will then be protected by the fastened seat belts.**

**We caution you not to rely on the presence of the airbags in order to avoid wearing your seat belt.**

**Warning!**

Airbags are designed to reduce the potential of injury in certain frontal (front airbags) impacts, or side (side impact and head protection window curtain airbags) impacts which may cause significant injuries, however, no system available today can totally eliminate injuries and fatalities.

The activation of the “SRS” temporarily releases a small amount of dust from the airbags. This dust, however, is neither injurious to your health, nor does it indicate a fire in the vehicle. The dust might cause some temporary breathing difficulty for people with asthma or other breathing trouble. To avoid this, you may wish to get out of the vehicle as soon as it is safe to do so. If you have any breathing difficulty but cannot get out of the vehicle after the airbag inflates, then get fresh air by opening a window or door.

The service life of the airbags extends to the date indicated on the label located on the driver side door latch post. To provide continued reliability after that date, they should be inspected by an authorized Mercedes-Benz Center at that time and replaced when necessary.

Your vehicle was originally equipped with airbags which are designed to activate in certain impacts exceeding a preset threshold to reduce the potential and severity of injury. It is important to your safety and that of your passenger that you replace deployed airbags and repair any malfunctioning airbags to ensure the vehicle will continue to provide crash protection for occupants.

**Warning!**

To reduce the risk of injury when the front airbags inflate, it is very important for the driver and front passenger to always be in a properly seated position and to wear your seat belt.

For maximum protection in the event of a collision always be in normal seated position with your back against the backrest. Fasten your seat belt and ensure that it is properly positioned on your body.

Since the airbag inflates with considerable speed and force, a proper seating and hands on steering wheel position will help to keep you at a safe distance from the airbag. Occupants who are unbelted, out of position or too close to the airbag can be seriously injured by an airbag as it inflates with great force in the blink of an eye:

- Sit properly belted in an upright position with your back against the backrest.
- Adjust the driver seat as far as possible rearward, still permitting proper operation of vehicle controls. The distance from the center of the driver's breastbone to the center of the airbag cover on the steering wheel must be at least ten inches (25 cm) or more. You should be able to accomplish this by a combination of adjustments to the seat and steering wheel. If you have any problems, please see your authorized Mercedes-Benz Center.
- Do not lean with your head or chest close to the steering wheel or dashboard.
- Keep hands on the outside of steering wheel rim. Placing hands and arms inside the rim can increase the risk and potential severity of hand/arm injury when driver front airbag inflates.
- Adjust the front passenger seat as far as possible rearward from the dashboard when the seat is occupied.

- Occupants, especially children, should never lean their heads in the area of the door where the side airbag inflates. This could result in serious injuries or death should the airbag be triggered.
- Children 12 years old and under must never ride in the front seat, except in a Mercedes-Benz authorized Baby Smart™ compatible child seat, which operates with the BabySmart™ system installed in the vehicle to deactivate the passenger side front airbag when it is properly installed. Otherwise they will be struck by the airbag when it inflates in a crash. If this happens, serious or fatal injury can result.

Failure to follow these instructions can result in severe injuries to you or other occupants.

## Restraint systems

72

**Safety guidelines for the seat belt, emergency tensioning retractor and airbag****Warning!**

- Damaged seat belts or belts that were highly stressed in an accident must be replaced and their anchoring points must also be checked. Use only belts installed or supplied by an authorized Mercedes-Benz Center.
- Airbags and “ETR’s” are designed to function on a one-time-only basis. An airbag or emergency tensioning retractor (ETR) that was activated must be replaced.
- No modifications of any kind may be made to any components or wiring of the “SRS”. This includes changing or removing any component or part of the “SRS”, the installation of additional trim material, badges etc. over the steering wheel hub, front passenger airbag cover, door trim panels, or door frame trims, and installation of additional electrical/electronic equipment on or near “SRS” components and wiring. Keep area between airbags and occupants free from objects (e.g. packages, purses, umbrellas, etc).

- Do not pass belts over sharp edges.
- Do not make any modification that could change the effectiveness of the belts.
- Do not use handles above doors for placing such items as coat hangers etc.
- An airbag system component within the steering wheel gets hot after the airbag has inflated. Do not touch.
- Improper work on the system, including incorrect installation and removal, can lead to possible injury through an unintended activation of the “SRS”.
- In addition, through improper work there is a risk of rendering the “SRS” inoperative or causing unintended airbag deployment. Work on the “SRS” must therefore only be performed by an authorized Mercedes-Benz Center.

- **For your protection and the protection of others, when scrapping the airbag unit or emergency tensioning retractor, our safety instructions must be followed. These instructions are available from your authorized Mercedes-Benz Center.**
- **Given the considerable deployment speed and the textile structure of the airbags, there is the possibility of abrasions or other injuries resulting from airbag deployment.**

When you sell your vehicle we strongly urge you to give notice to the subsequent owner that it is equipped with an “SRS” by alerting them to the applicable section in the Operator’s Manual.

## Infant and child restraint systems

We recommend all infants and children be properly restrained at all times while the vehicle is in motion. All lap-shoulder belts except the driver seat belt have special seat belt retractors for secure fastening of child restraints.

To activate, pull shoulder belt out completely and let it retract. During the seat belt retraction a ratcheting sound can be heard to indicate that the special seat belt retractor is activated. The belt is now locked.

To deactivate, release seat belt buckle and let seat belt retract completely. The seat belt can again be used in the usual manner.

Note:

For child seats with mounting fittings for tether anchorages refer to page 75 (installation of infant and child restraint systems).

### Warning!

**Never release the seat belt buckle while vehicle is in motion, since the special seat belt retractor will be deactivated.**

## Restraint systems

74

**Important!**

The use of infant or child restraints is required by law in all 50 states and all Canadian provinces.

Infants and small children should be seated in an appropriate infant or child restraint system properly secured by a lap-shoulder belt, and that complies with U.S. Federal Motor Vehicle Safety Standard 213 and Canadian Motor Vehicle Safety Standard 213.

A statement by the child restraint manufacturer of compliance with this standard can be found on the instruction label on the restraint and in the instruction manual provided with the restraint.

When using any infant or child restraint system, be sure to carefully read and follow all manufacturer's instructions for installation and use.

Please read and observe warning labels affixed to the inside of the vehicle and to infant or child restraints.

**Warning!**

**Children 12 years old and under must never ride in the front seat, except in a Mercedes-Benz authorized BabySmart™ compatible child seat, which operates with the BabySmart™ system installed in the vehicle to deactivate the passenger front airbag when it is properly installed. Otherwise they will be struck by the airbag when it inflates in a crash. If this happens, serious or fatal injury can result.**

**According to accident statistics, children are safer when properly restrained in the rear seating positions than in the front seating positions. Infants and small children must ride in back seats and be seated in an appropriate infant or child restraint system, which is properly secured with the vehicle's seat belt, fully in accordance with the child seat manufacturer's instructions.**

**Infants and small children should never share a seat belt with another occupant. During an accident, they could be crushed between the occupant and seat belt.**

**Children too big for child restraint systems must ride in back seats using regular seat belts. Position shoulder belt across chest and shoulder, not face or neck. A booster seat may be necessary to achieve proper belt positioning for children from 41 lbs. to the point where a lap/shoulder belt fits properly without one.**

**When the child restraint is not in use, remove it from the vehicle or secure it with the seat belt to prevent the child restraint from becoming a projectile in the event of an accident.**

## Installation of infant and child restraint systems

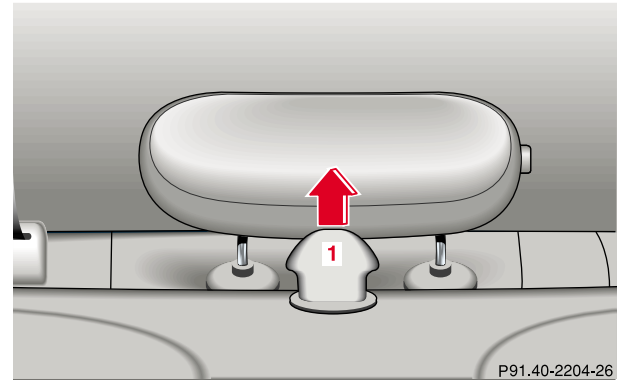

This vehicle is provided with tether anchorages for a top tether strap at each of the rear seating positions.

Prior to installing a tether strap, remove cover (1) from anchorage ring (2) and store in a convenient place (e.g. glove box).



## Restraint systems

76

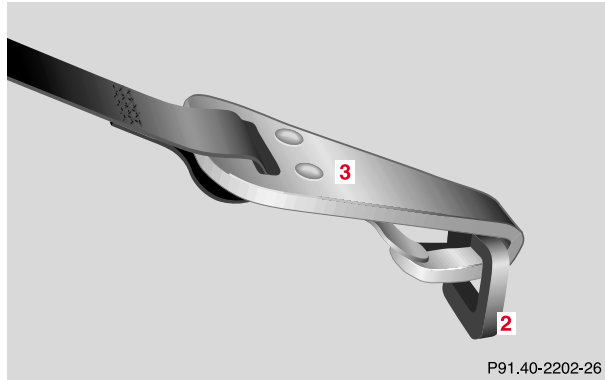

To secure a tether strap to the anchorage, securely fasten the hook (3), which is part of the tether strap, to the anchorage ring (2). For safety, please make sure that the hook has attached to the ring beyond the safety catch, as illustrated.

After removing the tether strap, reinstall the cover (1).

## Child seat mounts

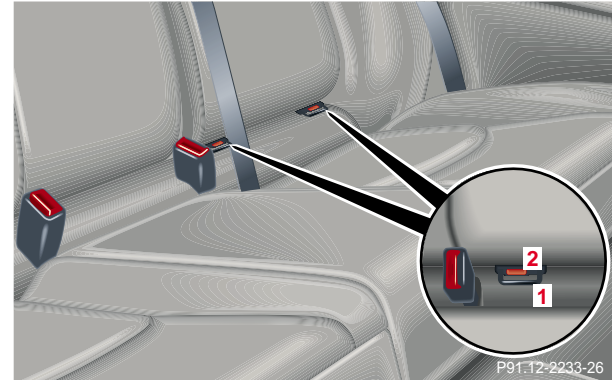

This vehicle is provided with two mounts (at each of the outer rear seats) for the installation of a child seat having the matching mounting fittings. The mounts can be folded back between the seat cushion and the backrest.

To install a child seat, the mounts (1) must be folded forward until they lock in place. To do so, grip inner side of mounts and fold forward. Install child seat according to the manufacturer's instructions.

To fold mounts (1) back, press down button (2) on each mount and return mount into its catch.

Note:

With a child seat installed in the left rear seat, the seat belt for the center seat occupied by a passenger must operate freely. Guide seat belt between its seat cushion mount and backrest mount along outside of right side child seat mount.

### Steering wheel adjustment (manual)

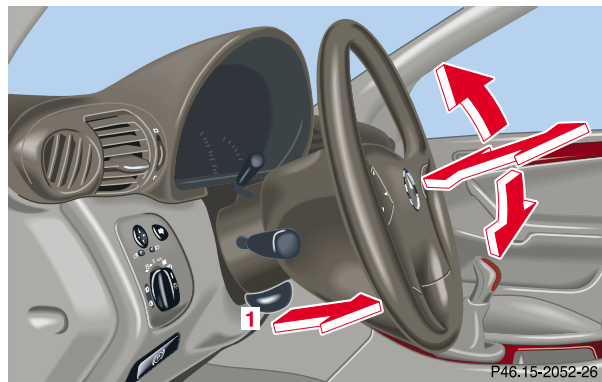

#### Warning!

**Do not adjust the steering wheel while driving. Adjusting the steering wheel while driving, or driving without the adjustment locked could cause the driver to lose control of the vehicle.**

## Restraint systems

78

Unlocking:

Pull handle (1) out to its stop.

Adjusting:

Move steering wheel to the desired position.

Locking:

Push handle (1) in until it engages.

**Important!**

Do not drive the vehicle until you have properly locked the steering column.

See “STEERING WH. ADJUST” on page 292 for malfunction and warning messages in the multifunction display.

## Steering wheel adjustment (electrical)

### Warning!

Do not adjust the steering wheel while driving. Adjusting the steering wheel while driving could cause the driver to lose the control of the vehicle.

When leaving the vehicle always remove the electronic key from the starter switch and lock your vehicle.

The steering wheel adjustment feature can also be operated with the driver's door open. Do not leave children unattended in the vehicle, or with access to an unlocked vehicle. Unsupervised use of vehicle equipment may cause serious personal injury.

To adjust the steering wheel position, turn the electronic key in starter switch to position 1 or 2. With the driver's door open, the steering wheel can also be operated with the electronic key removed or in starter switch position 0.

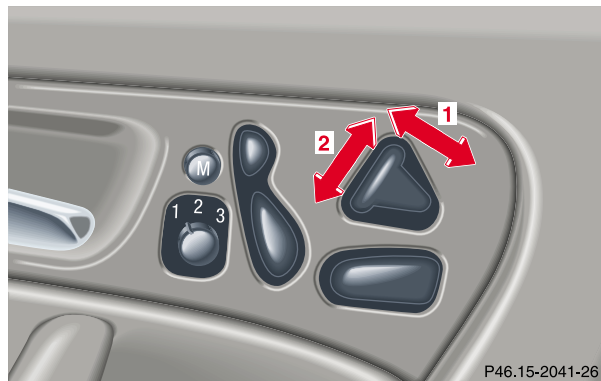

The switch is located on the driver's door.

### 1 Steering column, lengthen or shorten column

Move the switch to the front or rear.

### 2 Steering column, height

Move the switch up or down.

Note:

The steering wheel adjustment can be stored together with the seat and exterior mirror adjustment. See page 85 for notes on the memory function.

## Rear view mirrors

80

**Rear view mirrors****Inside rear view mirror**

Manually adjust the mirror.

**Rear view mirror, automatic antiglare**

Antiglare mode:

With the electronic key in starter switch position 2, the mirror reflection brightness responds to changes in light sensitivity.

With the gear selector lever in position “R”, or with the interior light switched on, the mirror brightness does not respond to changes in light sensitivity.

Note:

The automatic antiglare function does not react, if incoming light is not aimed directly at sensors in the mirror.

**Warning!**

**In the case of an accident liquid electrolyte may escape the mirror housing when the mirror glass breaks.**

**Electrolyte has an irritating effect. Do not allow the liquid come into contact with eyes, skin, clothing, or respiratory system. In cases it does, immediately flush affected area with water, and seek medical help if necessary.**

## Exterior rear view mirrors



The buttons are located above the exterior lamp switch. The memory button (4) is located on the driver's door.

### Warning!

Exercise care when using the passenger side exterior mirror. The mirror surface is convex (outwardly curved surface for a wider field of view). Objects in mirror are closer than they appear. Check your inside rear view mirror or glance over your shoulder before changing lanes.

## Exterior mirror adjustment

Turn the electronic key in starter switch to position 1 or 2.

Push button to select mirror to be adjusted:

Driver's side – Push button (1).

Passenger side – Push button (2).

Push the adjustment button (3) up, down, left or right according to the setting desired.

Notes:

The exterior rear view mirrors have electrically heated glass. The heater switches on automatically, depending on outside temperature.

If an exterior mirror housing is forcibly pivoted from its normal position, it must be repositioned by applying firm pressure until it snaps into place.

### Storing mirror positions in memory

The exterior rear view mirror positions are stored in memory with the seat/steering wheel adjustment and can be recalled when necessary. See page 85 for notes on the memory function.

## Rear view mirrors

82

**Parking position exterior mirror**

(only vehicles with power seats)

The passenger side exterior mirror can be adjusted and programmed to assist the driver during parking maneuvers (e.g. to observe the curb or other objects close to the vehicle).

With the electronic key in starter switch position 2, and the exterior rear view mirror switch in the passenger side position, the passenger side mirror will be turned downward when placing the gear selector lever in “R” reverse.

Note:

The mirror adjustment is only active if you select “ON” in the menu “MIRROR SETTING WHEN PARKING”. Refer to “CONVENIENCE” under individual settings, see page 121.

The mirror position can now be adjusted as desired.

At speeds above approximately 6 mph (10 km/h), upon shifting gear selector lever from “R” Reverse, or upon pressing the driver’s side mirror button, the passenger side mirror will return to its previous position.

To store passenger mirror parking position:

1. Turn the electronic key in starter switch to position 1 or 2.  
The vehicle must be stationary.
2. Select passenger side mirror and adjust the mirror to view the curb.
3. Push the memory button “M” (4).
4. Within 3 seconds push bottom of adjustment button (3).  
The mirror should not move.  
Repeat the memory procedure if the mirror moves.
5. Select driver side mirror. The passenger side mirror will return to its previous position.

Note:

One stored parking position is available for each of the two electronic main keys.

This is only possible if you select “ON” in the menu “SETTINGS KEY-DEPENDENT”. Refer to “CONVENIENCE” under individual settings, see page 121.



## Rear view mirrors

84

**Driver's side exterior mirror, antiglare mode**

Antiglare mode:

With the electronic key in starter switch position 2, the mirror reflection brightness responds to changes in light sensitivity.

With the gear selector lever in position "R", or with the interior light switched on, the mirror brightness does not respond to changes in light sensitivity.

Note:

The automatic antiglare function does not react, if incoming light is not aimed directly at sensors in the mirror.

**Warning!**

**In the case of an accident liquid electrolyte may escape the mirror housing when the mirror glass breaks.**

**Electrolyte has an irritating effect. Do not allow the liquid come into contact with eyes, skin, clothing, or respiratory system. In cases it does, immediately flush affected area with water, and seek medical help if necessary.**

**Important!**

Electrolyte drops coming into contact with the vehicle paint finish can only be completely removed while in their liquid state, by applying plenty of water.

## Memory function

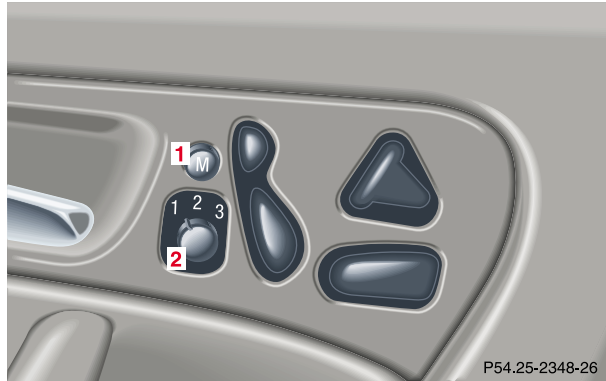

The memory and stored position buttons are located on the doors.

- 1** Memory button, used to store selected positions which can be retrieved by pressing
- 2** Stored position button  
Turn to position “1”, “2”, or “3”

Together with the driver's seat position you can store the positions for steering wheel and exterior rear view mirrors.

For the front passenger you can store the seat position.

Three stored positions for the driver's seat are available for each of the two electronic main keys.

## Memory function

86

**Storing positions into memory:**

With the electronic key in starter switch position 1 or 2 or with the relevant door open and the electronic key inserted in the starter switch.

Adjust the seat to the desired position.

Driver's seat:

You can also adjust the steering wheel and the exterior mirrors electrically for the driver's seat. See page 81 for exterior mirror adjustment and page 79 for steering wheel adjustment.

Turn button (2) to selected memory position.

Push memory button (1), release and push the position button (2) within 3 seconds.

**Recalling positions from memory:**

To recall a seat/steering wheel and exterior rear view mirror position, turn button (2) to selected memory position and press to recall.

The seat/steering wheel and exterior rear view mirror movement stops when the button is released.

**Caution!**

Do not operate the power seats using the memory button if the backrest is in an excessively reclined position. Doing so could cause damage to front or rear seats.

First move backrest to an upright position.

## Important!

Prior to operating the vehicle, the driver should check and adjust if necessary the seat height, seat position fore and aft, and backrest angle to insure adequate control, reach and comfort. The head restraint should also be adjusted for proper height. See also airbag section for proper seat positioning.

In addition, also adjust the steering wheel to ensure adequate control, reach, operation and comfort. Both the inside and outside rear view mirrors should be adjusted for adequate rearward vision.

Fasten seat belts. Infants and small children should be seated in a properly secured restraint system that complies with U.S. Federal Motor Vehicle Safety Standard 213 and Canadian Motor Vehicle Safety Standard 213.

All seat, head restraint, steering wheel, and rear view mirror adjustments as well as fastening of seat belts should be done before the vehicle is put into motion.

## Warning!

**Children 12 years old and under must never ride in the front seat, except in a Mercedes-Benz authorized BabySmart™ compatible child seat, which operates with the BabySmart™ system installed in the vehicle to deactivate the passenger side front airbag when it is properly installed. Otherwise they will be struck by the airbag when it inflates in a crash. If this happens, serious or fatal injury can result.**

**According to accident statistics, children are safer when properly restrained in the rear seating positions than in the front seating positions. Infants and small children must ride in back seats and be seated in an appropriate infant or child restraint system, which is properly secured with the vehicle's seat belt, fully in accordance with the child seat manufacturer's instructions.**

**A child's risk of serious or fatal injuries is significantly increased if the child restraints are not properly secured in the vehicle and the child is not properly secured in the child restraint.**

Instrument cluster

Instrument cluster

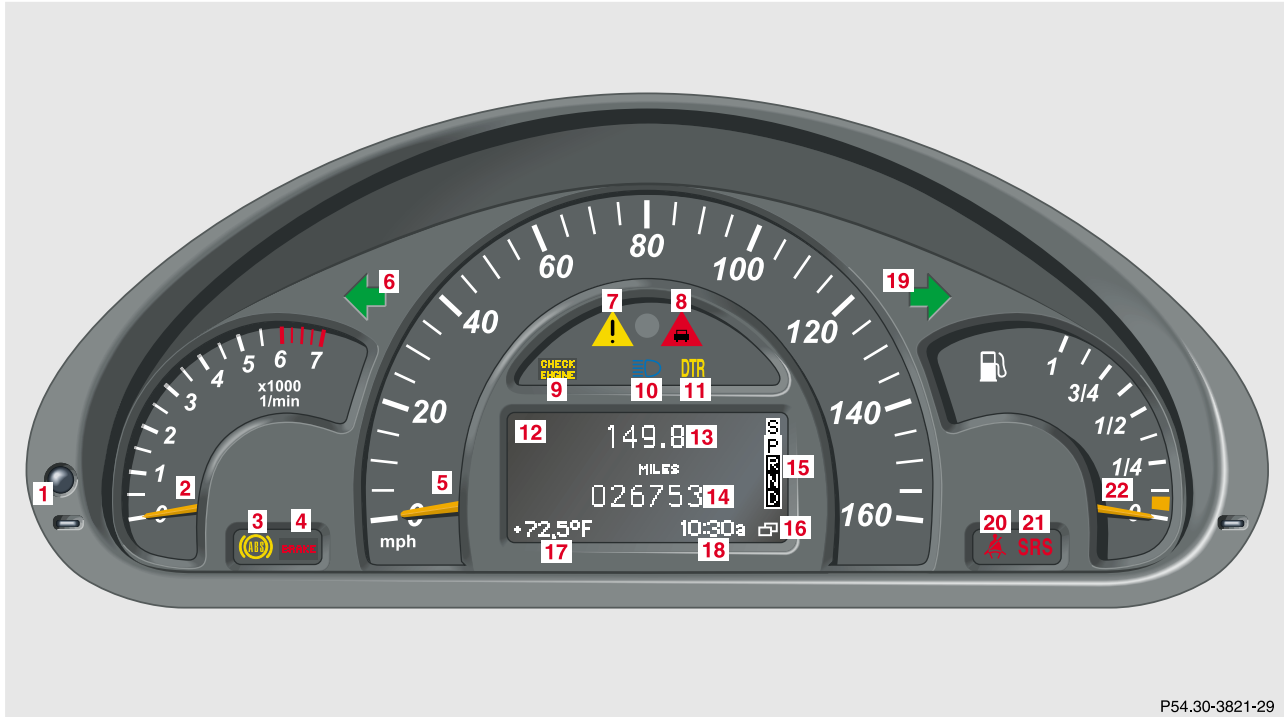

- 1** Knob for instrument cluster illumination, see page 90  
Reset knob for trip odometer, see page 91 and individual settings, see page 111
- 2** Tachometer
- 3** Antilock brake system (ABS) malfunction indicator lamp, see page 272
- 4** Brake fluid low or parking brake engaged, see page 278
- 5** Speedometer
- 6** Left turn signal indicator lamp, see combination switch on page 134
- 7** Electronic stability program (ESP) warning lamp, system is adjusting to road conditions, see page 273
- 8** Indicator lamp without function. It illuminates with the electronic key in starter switch position 2. It should go out when the engine is running.
- 9** CHECK ENGINE malfunction indicator lamp, see page 268
- 10** High beam headlamp indicator, see exterior lamp switch, page 130, and combination switch, see page 134
- 11** High beam headlamp indicator, exterior lamp switch, see page 130 and combination switch, see page 134.
- 12** Multifunction display, see page 92  
Instrument cluster display, see page 274
- 13** Trip odometer, see page 91 and 96
- 14** Main odometer, see page 96
- 15** Display for program mode and gear range indicators, page 237
- 16** Malfunction/warning message memory, see page 109
- 17** Outside temperature indicator, see page 91
- 18** Digital clock  
To set the time, see individual settings on page 111
- 19** Right turn signal indicator lamp, see combination switch on page 134
- 20** Fasten seat belts, see page 273
- 21** Supplemental restraint system (SRS) malfunction indicator lamp, see page 271
- 22** Fuel gauge with reserve and fuel cap placement warning lamp, see page 271

## Instrument cluster

90

**Activating instrument cluster display**

The instrument cluster is activated by:

- Opening the door<sup>1</sup>.
- Pressing button (1) on the instrument cluster<sup>1</sup>.
- Turning the electronic key in starter switch to position 1 or 2.
- Switching on the exterior lamps.

<sup>1</sup> The instrument cluster is activated for approximately 30 seconds.

**Instrument cluster illumination**

The instrument cluster illumination is dimmed or brightened automatically to suit daylight lighting conditions.

The instrument cluster illumination will also be adjusted when the vehicle's exterior lamps are switched on.

Display illumination, changing basic settings for driving at dusk or in darkness:

Rotate adjusting knob (1) clockwise – instrument lamp intensity increases.

Rotate adjusting knob (1) counterclockwise – instrument lamp intensity decreases.

Note:

It is not possible to select a basic brightness setting in daylight – the intensity is adjusted automatically.

## Outside temperature indicator (17)

### Warning!

**The outside temperature indicator is not designed to serve as an Ice-Warning Device and is therefore unsuitable for that purpose. Indicated temperatures just above the freezing point do not guarantee that the road surface is free of ice.**

The temperature sensor is located in the front bumper area. Due to its location, the sensor can be affected by road or engine heat during idling or slow driving. This means that the accuracy of the displayed temperature can only be verified by comparison to a thermometer placed next to the sensor, not by comparison to external displays (e.g. bank signs etc.).

Adaption to ambient temperature takes place in steps and depends on the prevailing driving conditions (stop-and-go or moderate, constant driving) and amount of temperature change.



Note:

The temperature indicator display can be set to read out in either Fahrenheit or Celsius. See page 111.

## Trip odometer (13)

To reset to “0” miles/km:

Activate the instrument cluster if it is not already activated, see page 90.

Press button  or  on the multifunction steering wheel repeatedly until the trip odometer appears if it is not displayed. See page 96.

Press button (1) on the instrument cluster, see page 90.

## Tachometer (2)

The red marking on the tachometer denotes excessive engine speed.

Avoid this engine speed, as it may result in serious engine damage that is not covered by the Mercedes-Benz Limited Warranty.

To help protect the engine, the fuel supply is interrupted if the engine is operated within the red marking.



## Multifunction steering wheel, multifunction display

92

## Multifunction steering wheel, multifunction display

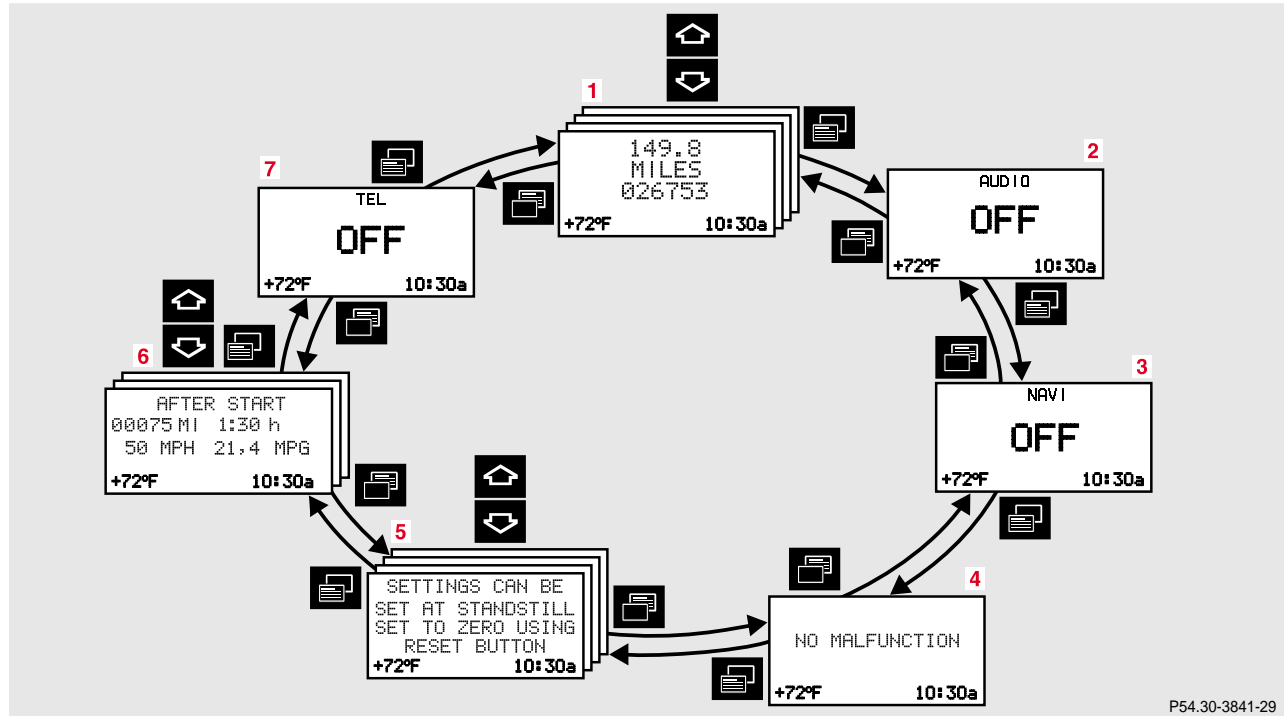



Depending on your vehicle's equipment, you may use the buttons on the multifunction steering wheel to call up, control and set the following systems in the multifunction display:

- 1** Trip odometer and main odometer, see page 91 and page 96
  - Flexible service system (FSS), see page 125
  - Vehicle speed, see page 96
  - Coolant temperature gauge, see page 124
  - Engine oil level indicator, see page 128
- 2** Audio systems, see page 98
  - Radio, see page 98
  - CD player, see page 99
  - Cassette player, see page 100

- 3** Navigation system, see page 106
- 4** Malfunction message memory, see page 109
- 5** Individual settings, see page 111
- 6** Trip computer, see page 107
  - After start
  - After reset
  - Fuel tank content
- 7** Telephone, see page 101

Press the  or  button repeatedly until the required system is displayed.

The display advances by one system each time the button is pressed.

You may call up additional displays within some of these categories by pressing the  or  button.

## Multifunction steering wheel, multifunction display

94

**Warning!**

**A driver's attention to the road must always be his/her primary focus when driving.**

**For your safety and the safety of others, selecting features through the multifunction steering wheel should only be done by the driver when traffic and road conditions permit it to be done safely. Programming individual settings in the system can only be made while the vehicle is at standstill.**

## Note:

The displays in the multifunction display can be set to German, English, French, Italian or Spanish language. See the "INSTRUMENT CLUSTER" individual settings on page 111 for instructions on changing the language setting.

The displays for the audio systems (radio, CD player, cassette player) will appear in English, regardless of the language selected.











**1** Multifunction display

**2** Multifunction steering wheel

Turn the electronic key in starter switch to position 1 or 2.

Press button:

- 3**  for next system
- 4**  for previous system
- 5**  for next display in system
- 6**  for previous display in system
- 7**  to increase the volume, see page 123
- 8**  to decrease the volume, see page 123
- 9**  to dial a telephone number, see page 101
- 10**  to end a call

See page 101 for telephone and page 105 for instructions on answering an incoming call.

**11** Horn pad

Press the  or  button repeatedly until the required system is displayed.

The display advances by one system each time the button is pressed.

You may call up additional displays in some systems by pressing the  or  button.

## Multifunction steering wheel, multifunction display

96

**Trip-/main odometer, FSS, coolant temperature, vehicle speed, engine oil level indicator**

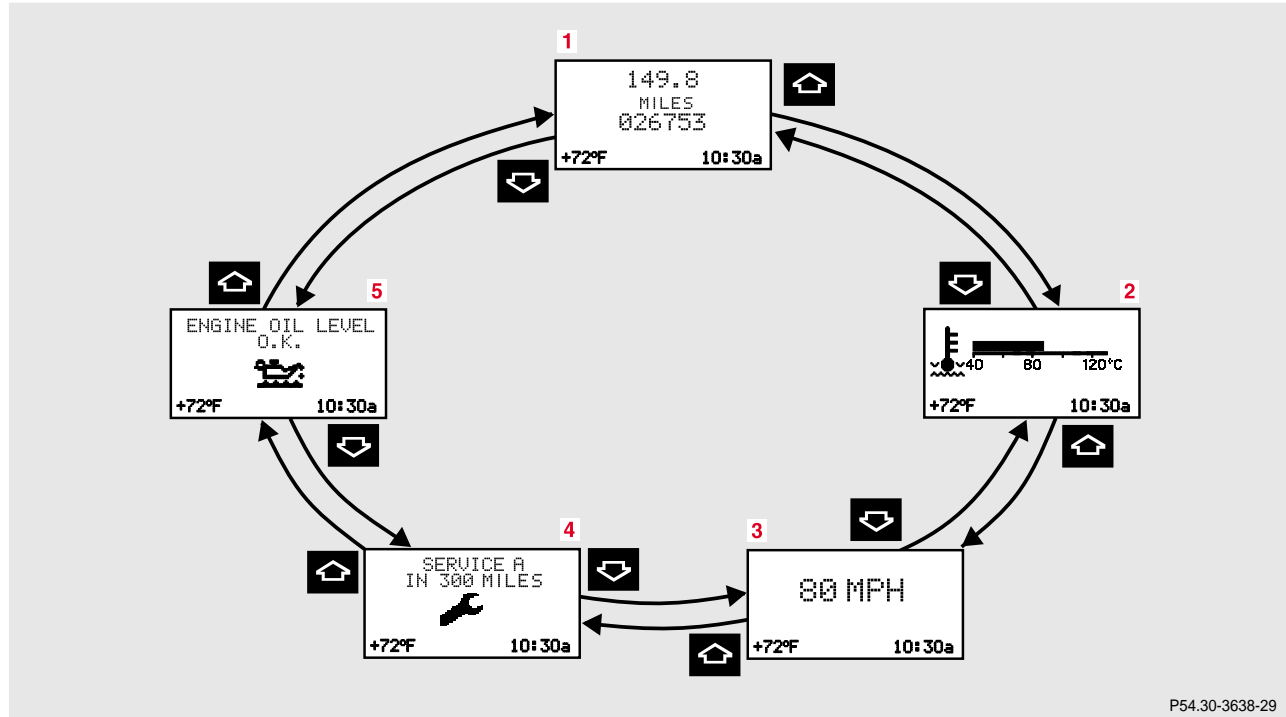

**1** Trip odometer and main odometer  
See page 91 for instructions on resetting the trip odometer.



**2** Coolant temperature gauge, see page 124



**3** Vehicle speed if “SPEED DISP.” is selected in individual settings under “INSTRUMENT CLUSTER”, refer to page 113

Outside temperature if “OUTSIDE TEMPERATURE” is selected in Individual settings under “INSTRUMENT CLUSTER”, see page 113

**4** FSS (Flexible service system), see page 125

**5** Engine oil level indicator, see page 128

Press  or  button repeatedly until the trip odometer and main odometer display (1) appears.

Press the  or  button repeatedly until the required display (2, 3, 4, 5, 1) appears.

Pressing the  or  button displays the next or previous system.

## Multifunction steering wheel, multifunction display

98

## Audio systems

## Radio

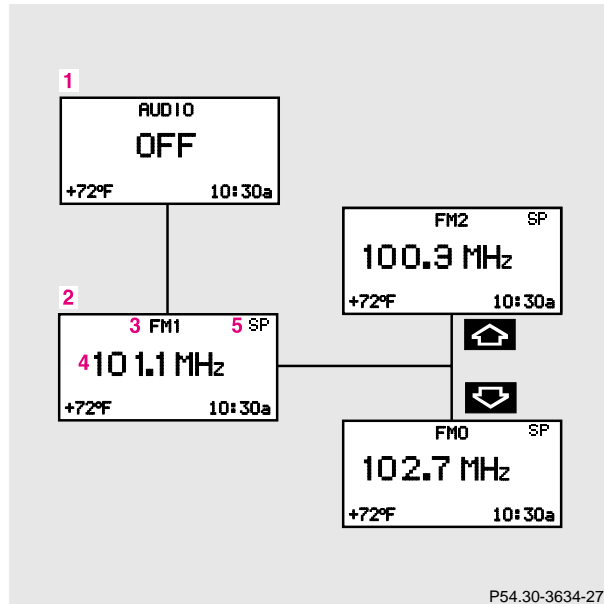

- 1 Audio system is switched off.
- 2 The radio is switched on.
- 3 Wave band setting and memory location number, where appropriate.
- 4 Station name setting or station frequency.
- 5 This only appears when “MEMORY” rather than “FREQUENCY” has been selected in the Individual settings. See page 119.

The radio must be switched on.

Press the or button repeatedly until display (2) appears.

Press button or repeatedly until the required station or frequency is displayed.

Use the of button to select a stored station or station frequency. This depends on the selection made in the “PRESS BUTTON IN AUDIO MODUS” setting menu. See individual settings, page 119.

Pressing the or button displays the next or previous system.

## CD player

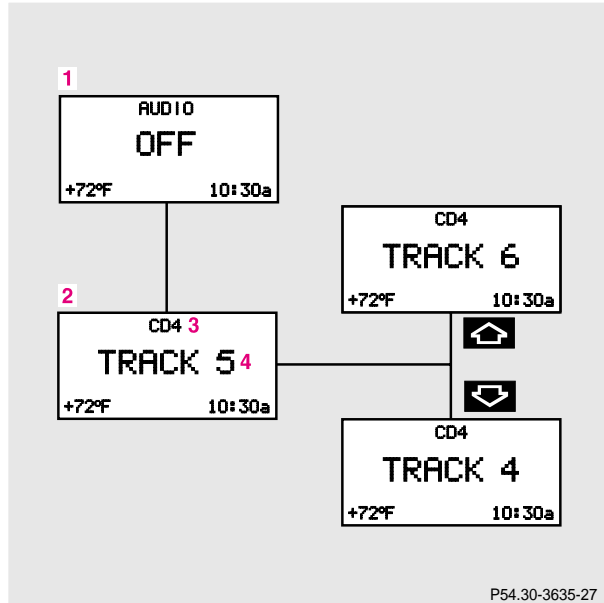

- 1 Radio system is switched off.
- 2 The CD player is switched on.
- 3 The number of the CD currently playing is displayed if you are using a CD changer.
- 4 Track number.



“TITLE” appears on vehicles with COMAND system.

“TRACK” appears on vehicles with audio system.

The radio must be switched on.

The CD player must be switched on.

Press the  or  button repeatedly until display (2) appears.

Press the  or  button repeatedly until the required track number (4) is displayed.

Pressing the  or  button displays the next or previous system.

Note:

To select a CD from the magazine, press a number on the audio system or the (optional) COMAND system key pad located in the center dashboard.



## Multifunction steering wheel, multifunction display

100

## Cassette player

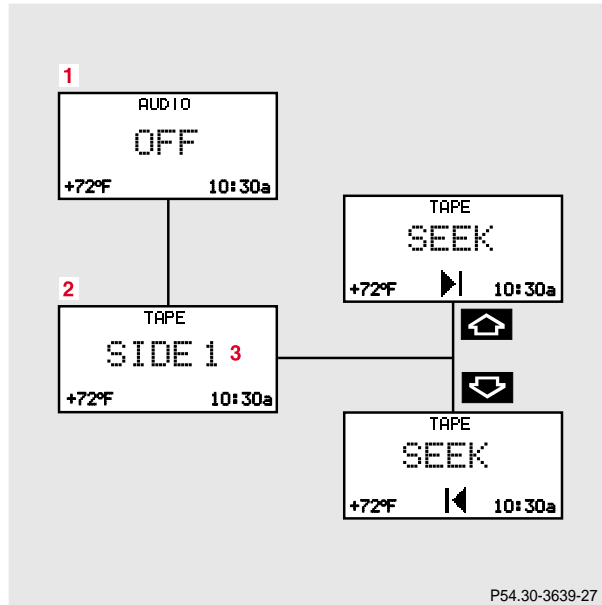

- 1 Audio system is switched off.
- 2 The cassette player is switched on.
- 3 Side being played.

The radio must be switched on.

The cassette player must be switched on.

Press the or button repeatedly until display (2) appears.

Pressing the button fast forward on to the next track.

Pressing the button rewinds the cassette to the beginning of the current track.

Pressing the or button displays the next or previous system.

Notes:

To select the reverse side of the tape, press button below track number on the audio system display, or enter request on the (optional) COMAND system located in the center dashboard.

## Telephone

### Telephone book

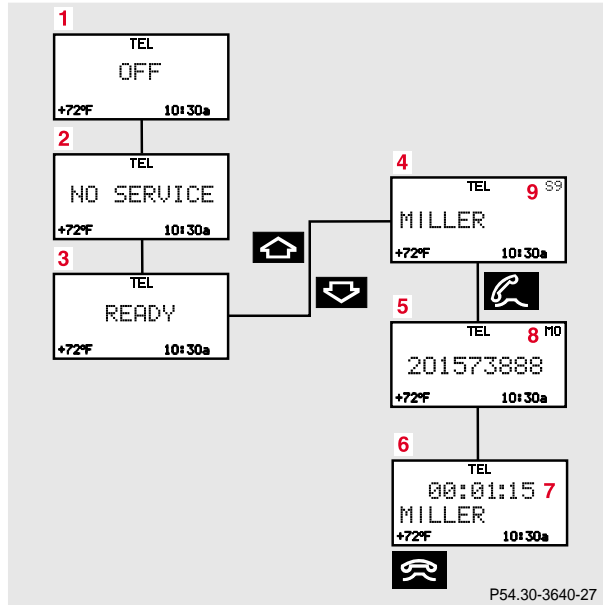







- 1 The telephone is switched off.
- 2 The vehicle is currently outside the transmitter or receiver range.
- 3 The telephone is ready for use.
- 4 Name selected from the telephone book.
- 5 Number for the name selected. The dialing commences.
- 6 Dialing is completed. The name is displayed. The display remains for the duration of the call.
- 7 Duration of call
- 8 Memory location number
- 9 Signal strength (in top right corner):  
Vehicles with audio system:  
the higher the number, the stronger the signal received from the net.  
Vehicles with COMAND (in top left corner):  
the higher the number of bars, the stronger the signal received from the net.

## Multifunction steering wheel, multifunction display

102

The telephone must be switched on.

Press the  or  button repeatedly until the display (3) appears. See the separate telephone instructions manual.

Pressing  or  “browses” alphabetically forward or backward through the telephone book, providing it was previously downloaded. See telephone operator’s manual for details concerning downloading. Pressing button  or  for longer than a second “browses” rapidly through the telephone book. The name selected appears in the display.

Note:

Press the  button if you do not wish to make a call.

The procedure is cancelled and display (4) appears.

Press the  button when the name you require appears in the display (4). The telephone number (5) is dialed.

The name will be displayed when dialing is completed. Display (6) remains for the duration of the call.

Pressing the  button hangs up and display (3) appears.

Pressing the  or  button displays the next or previous system.

## Redialing

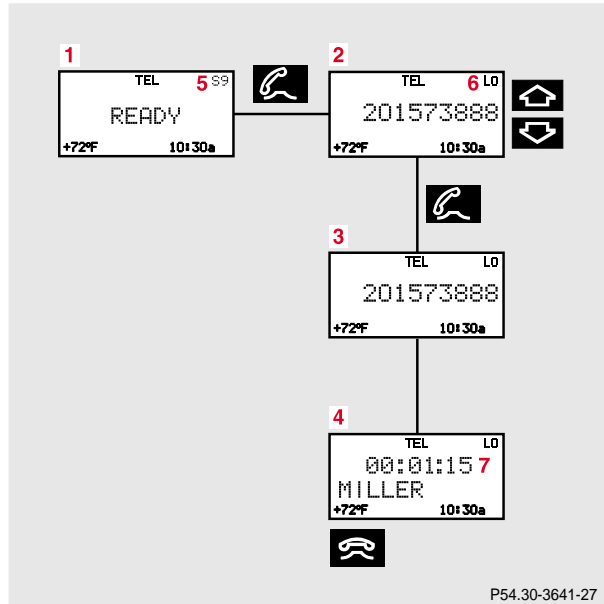



- 1 The telephone is ready for use.
- 2 Number or name stored in the redial memory.
- 3 Number in the redial memory – redialing has commenced.
- 4 Dialing is complete and the name stored in the telephone book is displayed or the number dialed will remain displayed if no name has been store. The display remains for the duration of the call.
- 5 Signal strength:  
Vehicles with audio system (in top right corner): the higher the number, the stronger the signal received from the net.  
Vehicles with COMAND (in top left corner): the higher the number of bars, the stronger the signal received from the net.
- 6 Memory location numbers – the 10 most recently dialed numbers are stored.  
L0, most recently dialed number,  
L1 to L9, previously dialed numbers.
- 7 Duration of call.



## Multifunction steering wheel, multifunction display

104

The telephone must be switched on.

Press the  or  button repeatedly until the display (1) appears.

Pressing the  button activates the redial memory and the most recently dialed number is displayed.

Pressing the  or  button “browses” forward or backward through the redial memory. The number selected appears in the display.

Note:

Press the  button if you do not wish to make a call.

The procedure is cancelled and display (1) appears.

Press the  button when the required number or name appears in the display (2).  
The telephone number (3) is dialed.

Once dialing is complete the name (4) is displayed if the name is stored in the telephone book; failing that the number dialed will remain displayed. The display remains for the duration of the call.

Pressing the  button hangs up and display (1) appears.

Pressing the  or  button displays the next or previous system.

## Incoming call

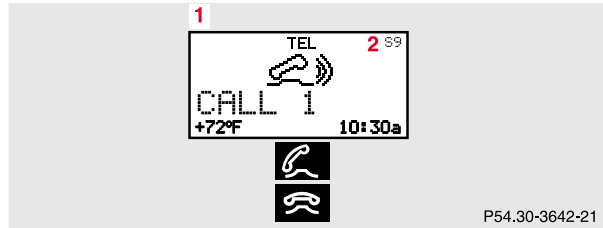

The telephone must be switched on.

- 1 “CALL” – you are being called.
- 2 Signal strength:  
Vehicles with audio system (in top right corner):  
the higher the number, the stronger the phone signal received by the antenna.  
Vehicles with COMAND (in top left corner):  
the higher the number of bars, the stronger the phone signal received by the antenna.

Press the  button to answer the call.

Press the  button to hang up or if you do not wish to answer the incoming call.

## Multifunction steering wheel, multifunction display

106

## Navigation system

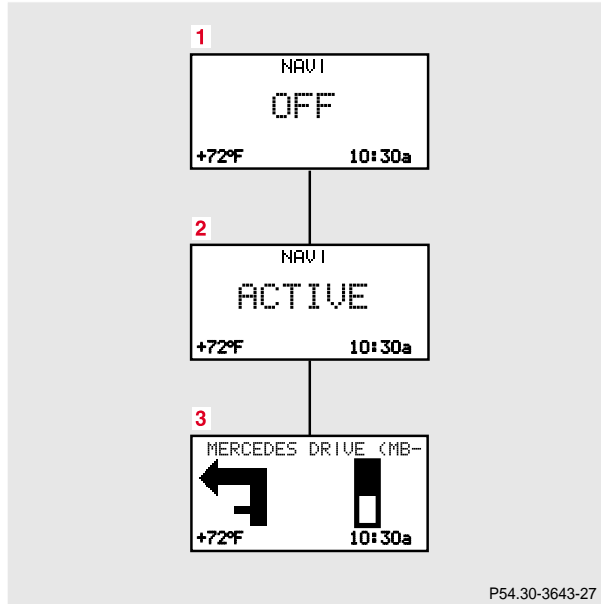

- 1 The navigation system is switched off.
- 2 The navigation system is switched on but no destination has been specified.
- 3 The navigation system is switched on and destination guidance is active.

Press the  or  button repeatedly until the required system is displayed.

See the separate COMAND (Cockpit Management and Data System) operator's manual for notes on the navigation system.

Pressing the  or  button displays the next or previous system.

## Trip computer

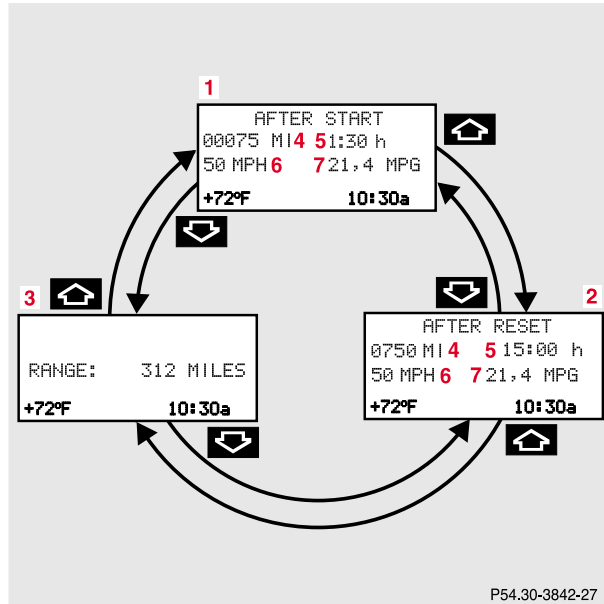

- 1 “AFTER START” – short distance memory
- 2 “AFTER RESET” – long distance memory
- 3 Estimated range remaining
- 4 Distance covered “AFTER START” or “AFTER RESET”
- 5 Elapsed time “AFTER START” or “AFTER RESET”
- 6 Average speed “AFTER START” or “AFTER RESET”
- 7 Average fuel consumption “AFTER START” or “AFTER RESET”

Press the button or repeatedly until the display (1, 2 or 3) appears.

Press the or button until the “AFTER START” short distance memory (1), the “AFTER RESET” long distance memory (2) or fuel tank contents and estimated range remaining indicator (3) appears.

Pressing the or button displays the next or previous system.

Note:



The display (1) always appears the next time the trip computer is called up.



## Multifunction steering wheel, multifunction display

108

**To reset the short “AFTER START” (1) or long “AFTER RESET” distance memory (2):**

Call up the relevant display (1 or 2) using the  or  button and press the reset knob on the instrument cluster, see page 88, until the values are reset to “0”.



Note:

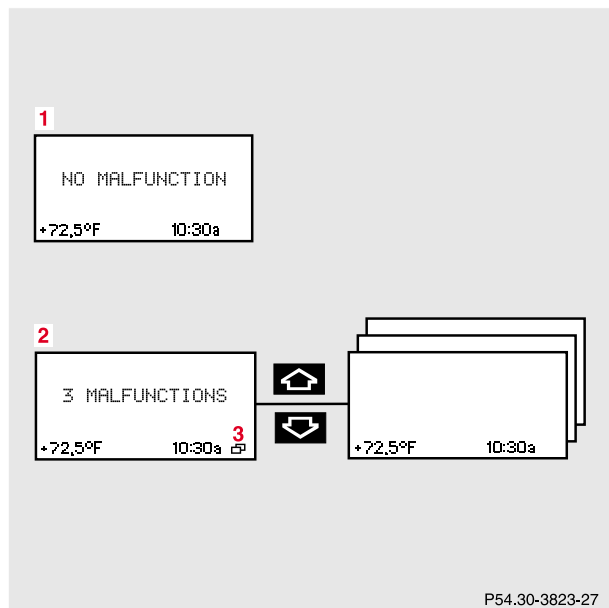

The “AFTER START” trip odometer reading is automatically reset after four hours of electronic key not being in starter switch position 1 or 2.

## Malfunction/warning message memory



- 1 There are no messages stored in the system.
- 2 Number of messages stored in the system.
- 3 There are messages stored in the system.

Press the  or  button repeatedly until the message memory (1 or 2) is displayed.

Press the  or  button if display (2) appears. The stored messages will now be displayed in order.

See page 274 for malfunction and warning messages.

Display (2) will reappear after you have scanned all the malfunction and warning messages.

Should any malfunction or warning messages be stored while driving, they will reappear in the display (2) when the electronic key is in starter switch position 0 or removed from the starter switch.

The malfunction or warning messages will now be displayed for approximately 5 seconds each.

Pressing the reset knob on the instrument cluster (see page 88) displays the malfunction and warning messages once more.

## Multifunction steering wheel, multifunction display

110

The message memory will be cleared when the electronic key is turned in the starter switch to position 1 or 2. Should any subsequent faults occur, they will be displayed in the message memory.

Pressing the  or  button displays the next or previous system.

**Important!**

Malfunction and warning messages are only indicated for certain systems and displayed to a low level of detail. The malfunction and warning messages are simply a reminder with respect to the operation of certain systems and do not replace the driver's responsibility to maintain the vehicle's operating safety by having all required maintenance and safety checks performed on the vehicle and by bringing the vehicle to an authorized Mercedes-Benz Center to address the malfunction and warning messages. See page 274, for malfunction and warning messages.

## Individual settings

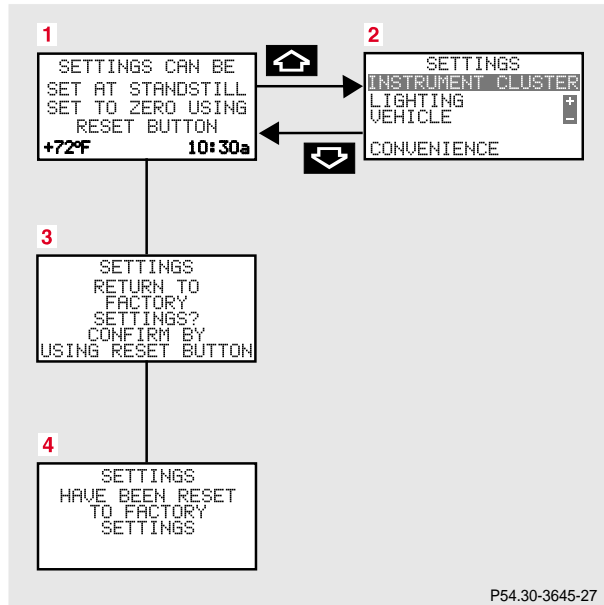

- 1 Preliminary display of the individual settings.
- 2 “SETTINGS” – the requested menu can be called up in this options menu:
  - “INSTRUMENT CLUSTER”, see page 113.
  - “LIGHTING”, see page 117.
  - “VEHICLE”, see page 119.
  - “CONVENIENCE”, see page 121.

The four menus contain additional submenus. Individual settings can be selected in these submenus.



- 3 See below for instructions on returning the setting menus to the factory settings.
- 4 Acknowledgment.



Note:



The displayed menu “SETTINGS” depends on the equipment of the vehicle.

## Multifunction steering wheel, multifunction display

112

Press the  or  button repeatedly until the individual setting preliminary display (1) appears.

Press the  or  button until the setting menu “SETTINGS” (2) is displayed.

Pressing the  or  button controls the selection marker in the setting menu.

“INSTRUMENT CLUSTER”, see page 113.

“LIGHTING”, see page 117.

“VEHICLE”, see page 119.

“CONVENIENCE”, see page 121

Pressing the  or  button displays the next or previous system.

Notes:

These settings may only be performed with the vehicle at standstill and with the electronic key in starter switch position 1 or 2.

The individual setting preliminary display (1) will appear if you speed up.

The setting menu previously called up will reappear when the vehicle stops, providing no other system has been called up in the meantime.

**To return menu “SETTINGS” (2) to its factory setting:**

- Call up the individual setting preliminary display (1) or display (2).
- Press the reset knob on the instrument cluster (see page 88) for approximately 3 seconds. Display (3) will appear.
- Press the reset knob on the instrument cluster once more. The menu “SETTINGS” is reset to factory settings, acknowledged by display (4).

The individual setting preliminary display (1) will appear if you do not press the reset knob on the instrument cluster within about 5 seconds. The setting menus will not be reset.

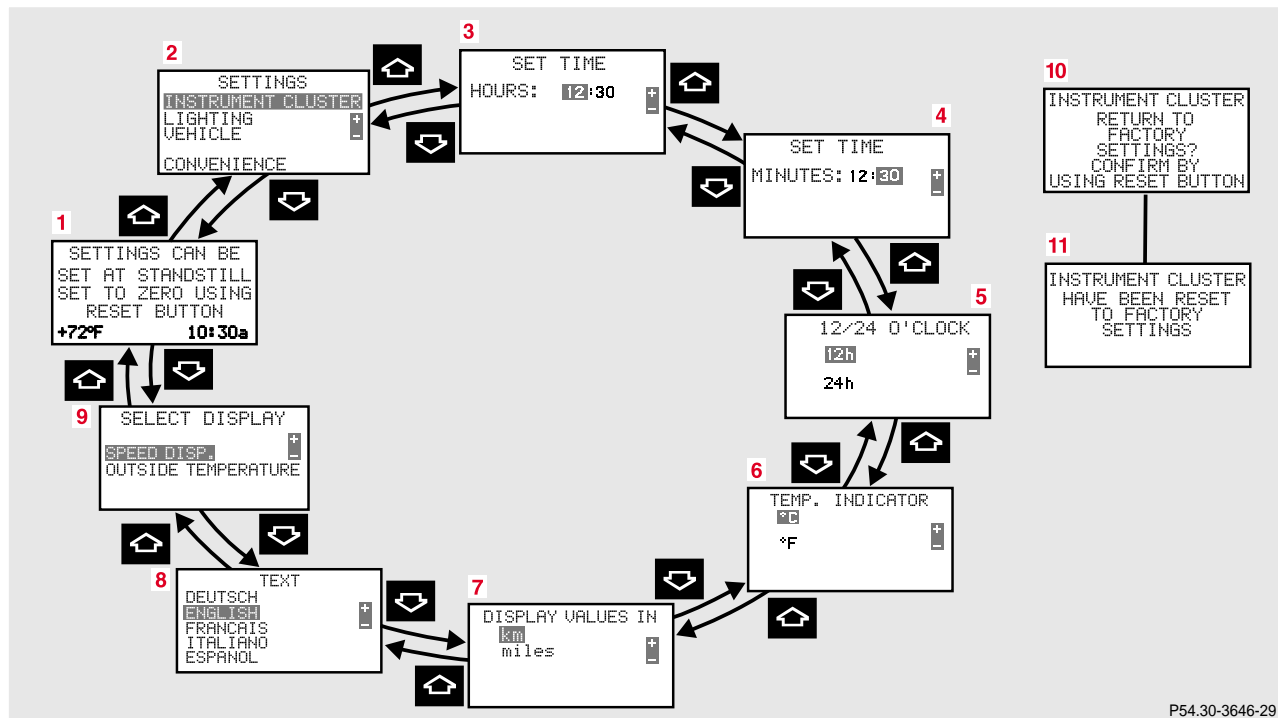

## “INSTRUMENT CLUSTER”







## Multifunction steering wheel, multifunction display

114



- 1 Preliminary display of the individual settings
  - 2 “SETTINGS” – the menu “INSTRUMENT CLUSTER” can be called up in this options menu.  
Pressing button **+** or **-** on the multifunction steering wheel controls the selection marker.
  - 3 “SET TIME” - “HOURS”<sup>1</sup>
  - 4 “SET TIME” - “MINUTES”<sup>1</sup>
  - 5 “12/24 O’CLOCK” – the unit set is displayed in the instrument cluster display
  - 6 “TEMP. INDICATOR” – the unit set is displayed in the outside temperature display, in the instrument cluster and in the automatic air conditioner display.
  - 7 “DISPLAY VALUES IN” – the unit set is displayed in the multifunction display (except speedometer).
  - 8 “TEXT” – sets the language used in the multifunction display
  - 9 “SELECT DISPLAY” – The selection “SPEED DISP.” respectively “OUTSIDE TEMPERATURE” is permanently displayed in the multifunction display. “SPEED DISP.” can be used to display, for instance, the present speed in km/h if the setting menu (7) “DISPLAY VALUES IN” is set to indicate miles.
  - 10 See page 116 for instructions on returning the setting menu “INSTRUMENT CLUSTER” to the factory setting.
  - 11 Acknowledgment.
- Note:
- Vehicles with COMAND:  
For setting clock and speedometer units, see separate COMAND operator’s manual.
- <sup>1</sup> Only vehicles without COMAND.  
Vehicles with COMAND, see separate operator’s manual.

Press the  or  button repeatedly until the individual setting preliminary display (1) appears.



Press the  or  button until the setting menu “SETTINGS” (2) is displayed.

Press button  or  until the menu “INSTRUMENT CLUSTER” is selected by the selection marker.

Press the  or  button until the required display (3 to 9) is displayed.

Pressing the  or  button sets the time in setting menus (3, 4) and controls the selection marker in the setting menus (5 to 9).

The settings made are stored and applied immediately.

The individual setting preliminary display (1) will appear again after you have run through all the setting menus. Pressing the  or  button displays the next or previous system.



## Multifunction steering wheel, multifunction display

116

**To return menu “INSTRUMENT CLUSTER” (5 to 9) to its factory setting:**

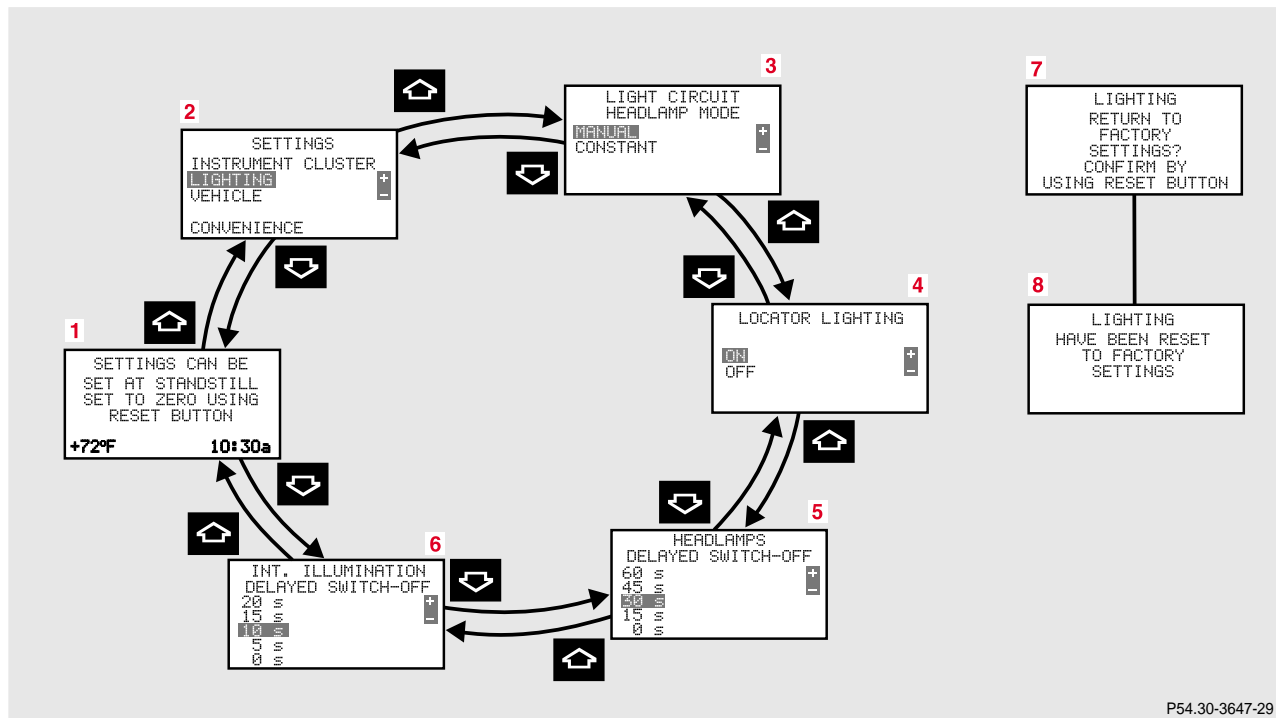

- Call up one of the setting menus(3 to 9).
- Press the reset knob on the instrument cluster, see page 88, for approximately 3 seconds. Display (10) will appear.
- Press the reset knob on the instrument cluster once more. The menu “INSTRUMENT CLUSTER” is reset to factory settings, acknowledged by display (11). The individual setting display “SETTINGS” (2) will appear if you do not press the reset knob on the instrument cluster within about 5 seconds. The setting menus will not be reset.

# “LIGHTING”







## Multifunction steering wheel, multifunction display



118





- 1 Preliminary display of the individual settings
- 2 “SETTINGS” – in this options menu you can call up the menu “LIGHTING”.  
Pressing button  or  on the multifunction steering wheel controls the selection marker.
- 3 “LIGHT CIRCUIT HEADLAMP MODE”<sup>1</sup>, see page 131.
- 4 “LOCATOR LIGHTING”, see page 133.
- 5 “HEADLAMPS DELAYED SWITCH-OFF”, see “Night security illumination” on page 132.
- 6 “INT. ILLUMINATION DELAYED SWITCH-OFF”, see “Interior lighting” on page 189.
- 7 Returning the setting menu “LIGHTING” to the factory setting.
- 8 Acknowledgment.



<sup>1</sup> Except Canada

Press the  or  button repeatedly until the individual setting preliminary display (1) appears.

Press the  or  button until the setting menu “SETTINGS” (2) is displayed.

Press button  or  until the menu “LIGHTING” is selected by the selection marker.

Press the  or  button until the required display (3 to 6) is displayed. Pressing the  or  button controls the selection marker. The settings made are stored and applied immediately.

The individual setting preliminary display (1) will appear again after you have run through all the setting menus. Pressing the  or  button displays the next or previous system.

**To return menu “LIGHTING” (3 to 6) to its factory setting:**

- Call up menu (3 to 6).
- Press the reset knob on the instrument cluster (see page 88) in the instrument cluster for approximately 3 seconds. Display (7) will appear.
- Press the reset knob on the instrument cluster once more. The menu “LIGHTING” is reset to factory settings, acknowledged by display (8).  
The individual setting display “SETTINGS” (2) will appear if you do not press the reset knob on the instrument cluster within about 5 seconds. The setting menus will not be reset.



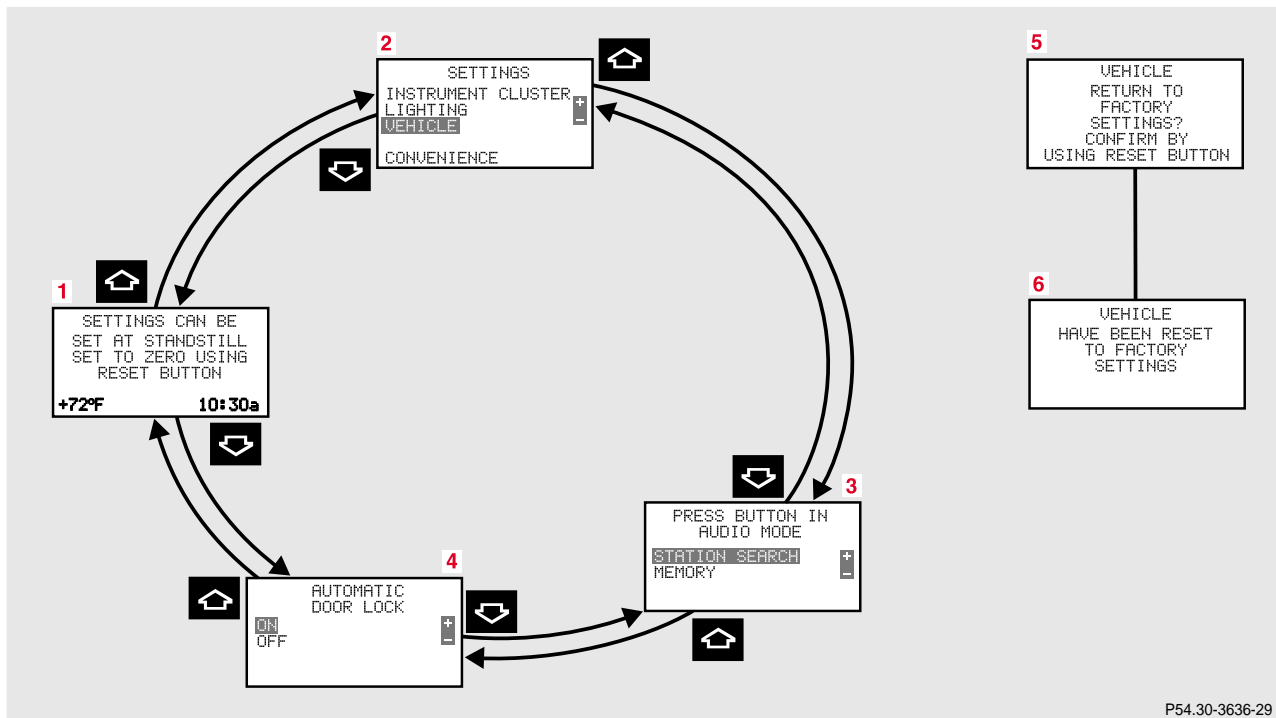



## “VEHICLE” (audio and central locking system)







P54.30-3636-29



## Multifunction steering wheel, multifunction display





120



- 1 Preliminary display of the individual settings
- 2 “SETTINGS” – in this options menu you can call up the menu “VEHICLE”.  
Pressing button  or  on the multifunction steering wheel controls the selection marker.
- 3 “PRESS BUTTON IN AUDIO MODE”  
– radio adjustment “STATION SEARCH”: use the  or  button to select a frequency.  
– radio adjustment “MEMORY”: use the  or  button to select a stored station (preset memory).
- 4 “AUTOMATIC DOOR LOCK”, see automatic central locking on page 34.
- 5 Returning the setting menu “VEHICLE” to the factory setting.
- 6 Acknowledgment.

Press the  or  button repeatedly until the individual setting preliminary display (1) appears.

Press the  or  button until the setting menu “SETTINGS” (2) is displayed.

Press button  or  until the menu “VEHICLE” is selected by the selection marker.

Press the  or  button until the required display (3 to 4) is displayed. Pressing the  or  button controls the selection marker. The settings made are stored and applied immediately.

The individual setting preliminary display (1) will appear again after you have run through all the setting menus. Pressing the  or  button displays the next or previous system.

#### To return menu “VEHICLE” (3 and 4) to its factory setting:

- Call up menu (3 or 4).
- Press the reset knob on the instrument cluster (see page 88) in the instrument cluster for approximately 3 seconds. Display (5) will appear.
- Press the reset knob on the instrument cluster once more. The menu “VEHICLE” is reset to factory settings, acknowledged by display (6).  
The individual setting display “SETTINGS” (2) will appear if you do not press the knob for instrument cluster illumination within about 5 seconds. The setting menus will not be reset.

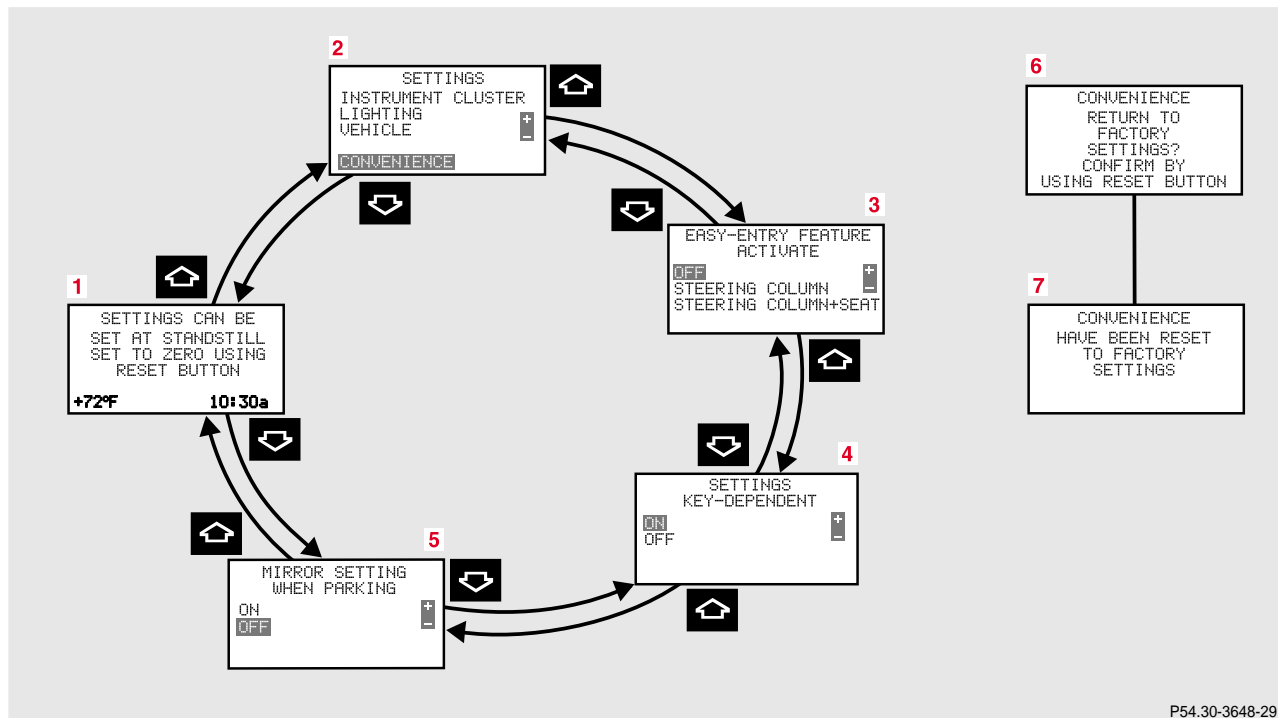

## “CONVENIENCE” (only vehicles with power seats)







P54.30-3648-29



## Multifunction steering wheel, multifunction display





122



- 1 Preliminary display of the individual settings
- 2 “SETTINGS” – in this options menu you can call up the menu “CONVENIENCE”.  
Pressing button  or  on the multifunction steering wheel controls the selection marker.
- 3 “EASY-ENTRY FEATURE ACTIVATE”, see page 41.
- 4 “SETTINGS KEY-DEPENDENT”  
if setting “ON” is selected, all settings selected in the individual setting can be stored key-dependent in memory. Memory function, see page 85.
- 5 “MIRROR SETTING WHEN PARKING” – the passenger side exterior mirror can be adjusted and programmed to assist the driver during parking maneuvers, see page 82.
- 6 Returning the setting menu “CONVENIENCE” to the factory setting.
- 7 Acknowledgment.

Press the  or  button repeatedly until the individual setting preliminary display (1) appears.

Press the  or  button until the setting menu “SETTINGS” (2) is displayed.

Press button  or  until the menu “CONVENIENCE” is selected by the selection marker.

Press the  or  button until the required display (3 to 5) is displayed. Pressing the  or  button controls the selection marker. The settings made are stored and applied immediately.

The individual setting preliminary display (1) will appear again after you have run through all the setting menus. Pressing the  or  button displays the next or previous system.

### To return menu “CONVENIENCE” (3 to 5) to its factory setting:

- Call up menu (3 to 5).
- Press the reset knob on the instrument cluster, see page 88, in the instrument cluster for approximately 3 seconds. Display (6) will appear.
- Press the reset knob on the instrument cluster once more. The menu “CONVENIENCE” is reset to factory settings, acknowledged by display (7). The individual setting display “SETTINGS” (2) will appear if you do not press the reset knob on the instrument cluster within about 5 seconds. The setting menus will not be reset.

### Setting the audio volume

You can only adjust the volume of the system currently in use.

Vehicles with COMAND system:

The volume setting for each system (audio, telephone, navigation and voice recognition system) is stored separately.

Setting button:

 increases the volume.

 reduces the volume.





## Flexible service system

124

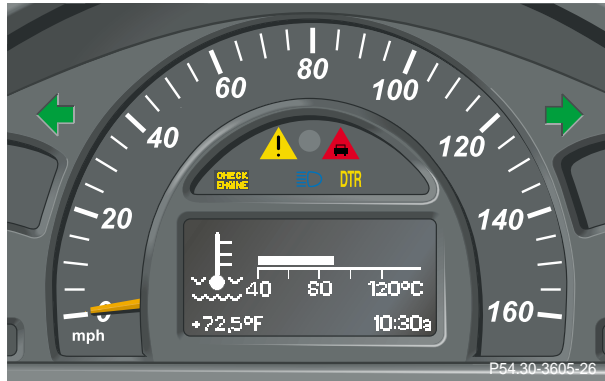
## Coolant temperature gauge



Turn the electronic key in starter switch to position 1 or 2.

Call up the trip odometer and main odometer by pressing button  or  on the multifunction steering wheel. See page 96.

Press button  or  until the coolant temperature gauge appears.

During severe operating conditions and stop-and-go city traffic, the coolant temperature may rise close to 120°C.

The engine should not be operated with the coolant temperature above 120°C. Doing so may cause serious engine damage which is not covered by the Mercedes-Benz Limited Warranty.

**Warning!**

- Driving when your engine is badly overheated can cause some fluids which may have leaked into the engine compartment to catch fire. You could be seriously burned.
- Steam from an overheated engine can cause serious burns and can occur just by opening the engine hood. Stay away from the engine if you see or hear steam coming from it.

**Turn off the engine, get out of the vehicle and do not stand near the vehicle until it cools down.**

Note:

Excessive coolant temperatures trigger a warning in the multifunction display. See page 282.

## Flexible service system (FSS) (service indicator)



The FSS permits a flexible service schedule that is directly related to the operating conditions of the vehicle.

The symbol  or  appears together with a message in the multifunction indicator prior to the next suggested service.

Depending on operating conditions throughout the year, the next service is calculated and displayed in days or distance remaining.

The message is displayed for approximately 10 seconds when turning the electronic key in starter switch to position 2, or while driving when reaching the service warning threshold.

The symbols and messages indicate the type of service to be performed:

 Service A

 Service B

One of the following messages will appear in the display (e.g. Service A):

“SERVICE A – IN xx DAYS”

“SERVICE A – IN xx MILES” (Canada: KM)

“SERVICE A – EXCEEDED BY xx DAYS”

“SERVICE A – EXCEEDED BY xx MILES” (Canada: KM)

“SERVICE A – DUE NOW”

The next service due date is displayed either in days or in miles, depending on your driving style.

Once the suggested service term has passed, the symbol and message appear for approximately 30 seconds and a signal sounds every time when turning the electronic key in starter switch to position 2.



## Flexible service system

126



The service indicator disappears automatically after 30 seconds or if the knob for instrument cluster illumination, see page 88, in the instrument cluster is pressed.

Calling up service indicator manually:

Turn the electronic key in starter switch to position 1.

Call up the trip odometer and main odometer by pressing button  or  on the multifunction steering wheel until the display appears. See page 96.

Press button  or  until the FSS indicator appears.

The next or previous system is displayed by pressing button  or .

**Important!**

The FSS indicator is not an engine oil level indicator. See page 128 for engine oil level indicator.

Note:



When disconnecting vehicle battery for one or more days at a time, such days will not be counted. Any such days not counted by the FSS can be added by your Mercedes-Benz Center.

The interval between services is determined by the type of driving for which the vehicle is used. For example, driving at extreme speeds, and cold starts combined with short distance driving in which the engine does not reach operating normal temperature, reduce the interval between services.

Following a completed A or B service the Mercedes-Benz Center sets the counter mileage to 10 000 miles (Canada: 15 000 km) and 365 days.

The counter can also be set by any individual. To do so:

Turn the electronic key in starter switch to position 1.

To call up the trip odometer and main odometer, press button  or  on the multifunction steering wheel until the display appears. See page 96.

Press button  or  until the FSS indicator appears.

Press the reset knob on the instrument cluster, see page 88, for approximately 2 seconds.

The multifunction display will show the question: “DO YOU WANT TO RESET SERVICE INTERVAL? – CONFIRM BY PRESSING R”

Press the reset knob on the instrument cluster again to reset the service indicator.

The new service indicator is displayed with the reset distance of 10 000 miles (Canada 15 000 km).

If the FSS counter was inadvertently reset, have a Mercedes-Benz Center correct it.

However you choose to set your reference numbers, the scheduled services as posted in the Service Booklet must be followed to properly care for your vehicle.

## Engine oil level indicator

128

## Engine oil level indicator

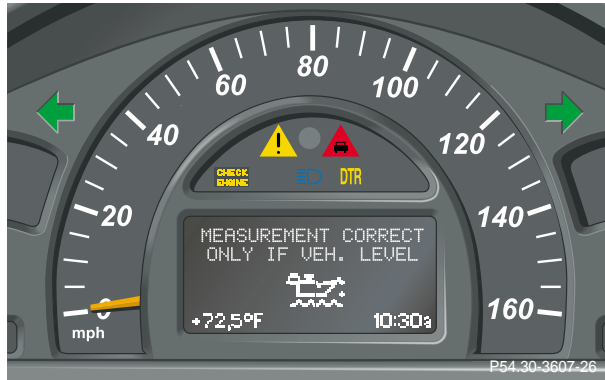

To check the engine oil level, park vehicle on level ground, with engine at normal operational temperature.

Check oil level approximately 5 minutes after stopping the engine, allowing for the oil to return to the oil pan.



The message “PERF. SERV. ON TIME” (perform service [engine oil level check] on time) will be displayed if the required waiting period has not been observed after stopping the engine:





- with engine at operational temperature approximately 5 minutes.

- with engine not at operational temperature up to approximately 30 minutes.

The engine oil level check can be repeated after a short time.

Turn the electronic key in starter switch to position 2.

To call up the trip odometer and main odometer, press button  or  on the multifunction steering wheel until the display appears. See page 96.

Press button  or  on the multifunction steering wheel repeatedly until the “MEASUREMENT CORRECT – ONLY IF VEH. LEVEL” engine oil level indicator appears. This indicator is only a reminder. Measurement can be cancelled by pressing button  or  if the vehicle is not parked on level ground. An incorrect reading will be recorded if you do not cancel the measurement. Move the vehicle to level ground and measure again.

The electronic key in starter switch is not in position 2 if the “ENGINE OIL LEVEL – SWITCH ON IGNITION” message appears.

The “ENGINE OIL LEVEL – MEASURING NOW” message is displayed after approximately 3 seconds.

One of the following messages will subsequently appear on the indicator:

**“ENGINE OIL LEVEL – O.K.”**

No oil needs to be added.

**“ENGINE OIL LEVEL – ADD 1.0 QUART”**

(Canada: 1.0 L)

**“ENGINE OIL LEVEL – ADD 1.5 QUART”**

(Canada: 1.5 L)

**“ENGINE OIL LEVEL – ADD 2.0 QUART”**

(Canada: 2.0 L)

See “Checking engine oil level”, on page 300 for instructions on adding engine oil.

**“ENGINE OIL LEVEL – REDUCE OIL LEVEL”**

Do not overfill the engine.

Excessive oil must be siphoned or drained off. It could cause damage to the engine and catalytic converter not covered by the Mercedes-Benz Limited Warranty.

The “PERF. SERV. ON TIME” message will be displayed if a proper oil level check cannot be performed. The engine oil level check can be repeated after a short while.

Perform the engine oil level check with the dipstick, if it cannot be completed via the multifunction display.

See “Checking engine oil level”, on page 300.

In this case we recommend that you have the system checked at a Mercedes-Benz Center.

Notes:

See malfunction and warning messages on page 274 and page 283 if an engine oil level indicator appears on the multifunction display when the engine is running.

The engine oil level cannot be checked while the engine is running. The “ENGINE OIL LEVEL – NOT WHEN ENGINE ON” message will appear.

### Engine oil consumption

Engine oil consumption checks should only be made after the break-in period. During the break-in period, higher oil consumption may be noticed and is normal. Frequent driving at high engine speeds results in increased consumption.

## Exterior lamp switch

130

## Exterior lamp switch



- 0** Off
- AUTO** Automatic headlamp mode, see below.
- P<->** Parking lamps (also side marker lamps, taillamps, licence plate lamps, instrument panel lamps)  
Canada only: When the engine is running, the low beam is additionally switched on.
- ☁** Parking lamps plus low beam or high beam headlamps (combination switch pushed forward).

- P<->** Standing lamps, right (turn left one stop)
- <-P<** Standing lamps, left (turn left two stops)
- ☁** Front fog lamps (pull out one stop) with parking lamps and/or low beam headlamps on. Green indicator in lamp switch comes on.
- 0☁** Rear fog lamp (pull out to second detent) in addition to the front fog lamps. Yellow indicator in lamp switch comes on.

## Note:

With the electronic key removed and the driver's door open, a warning sounds if the vehicle's exterior lamps (except standing lamps) are not switched off.

Fog lamps will operate with the parking lamps and/or the low beam headlamps on. Fog lamps should only be used in conjunction with low beam headlamps. Consult your State or Province Motor Vehicle Regulations regarding allowable lamp operation.

Fog lamps are automatically switched off when the exterior lamp switch is turned to position **0** or **AUTO**.

## Headlamp mode (HEADLAMPS)

(USA only)

The headlamps can be switched on and off manually or automatically, or switched to daytime running lamp mode.

Manual operation:

The low beam headlamps, parking lamps and license plate lamps can be switched on and off with the exterior lamp switch. For exterior lamp switch, see page 130.

### Warning!

**The driver is responsible for the operation of the vehicle's lights at all times. The automatic headlamp feature is only an aid to the driver. Switch on the vehicle lights by hand when driving or traffic conditions require you to do so.**

Automatic operation:

With electronic key in starter switch in position 1 turn exterior lamp switch to position **AUTO**.

The parking lamps switch on and off automatically depending on the brightness of the ambient light.

With the engine running and exterior lamp switch in position **AUTO**:

The low beam headlamps, parking lamps and license plate lamps are switched on and off automatically depending on the brightness of the ambient light.

The low beam headlamps, parking lamps and license plate lamps can still be switched on and off manually using the exterior lamp switch.

Note:

The headlamps will not be automatically switched on under foggy conditions.



## Exterior lamp switch

132

**Daytime running lamp mode**

Turn exterior lamp switch to position **0**.

When the engine is running, the low beam headlamps (includes parking lamps and license plate lamps) are automatically switched on.

Canada only:

When shifting from a driving position to position “N” or “P”, the low beam switches off (3 minutes delay).

For nighttime driving the exterior lamp switch should be turned to position  to permit activation of the high beam headlamps.

USA only:

The high beam headlamps can also be activated when driving with the daytime running lamp mode activated and exterior lamp switch in position **0**.

See page 130 for notes on the exterior lamp switch.

To activate the daytime running lamp mode, see “Individual settings” – “LIGHTING” on page 117.

**Night security illumination**

When turning off the engine, the exterior lamps switch on for added illumination, if they were previously switched on (except in daytime running mode). After the last door has been closed the lamp-on time period commences.

The lamp-on time period for night security illumination can be set at several different timed levels from 0 (off) to 60 seconds, see “Individual settings” – “LIGHTING” on page 117.

Notes:

Within 10 minutes after closing the last door the night security illumination can be reactivated by opening a door.

See “Individual settings” – “LIGHTING” on page 117 for instructions on how to activate the function.

Deactivating night security illumination temporarily:

Turn the electronic key in starter switch to position 0 then to position 2 and back to position 0 again before getting out of the vehicle. The night security illumination will not be activated when the door is opened.

## Locator lighting

After unlocking the vehicle with the electronic main key during darkness, the fog lamps, parking lamps, taillamps and license plate lamps switch on for approximately 40 seconds.

The exterior lamps will be switched off when opening the driver's door.

See "Individual settings" – "LIGHTING" on page 117 for instructions on how to activate the function.

## Headlamp cleaning system



Turn the electronic key in starter switch to position 1. The headlamps will be cleaned with a high-pressure water jet when you press the headlamp washer button (1).



See page 302 for instructions on filling up the windshield/headlamp washer reservoir.

## Combination switch

134

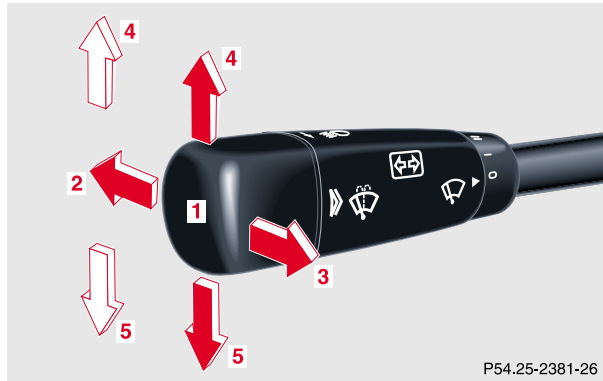
## Combination switch



- 1 Low beam  
(exterior lamp switch position )
- 2 High beam  
(exterior lamp switch position )

- 3 High beam flasher (high beam available independent of exterior lamp switch position)
- 4 Turn signals, right
- 5 Turn signals, left

To signal minor directional changes, such as changing lanes on a highway, move combination switch briefly to the point of resistance only and release. The turn signals blink three times.

To operate the turn signals continuously, move the combination switch past the point of resistance (up or down). The switch is automatically canceled when the steering wheel is turned to a large enough degree.

**Turn signal failure**

If one of the turn signals fails, the turn signal indicator system flashes and sounds at a faster than normal rate.

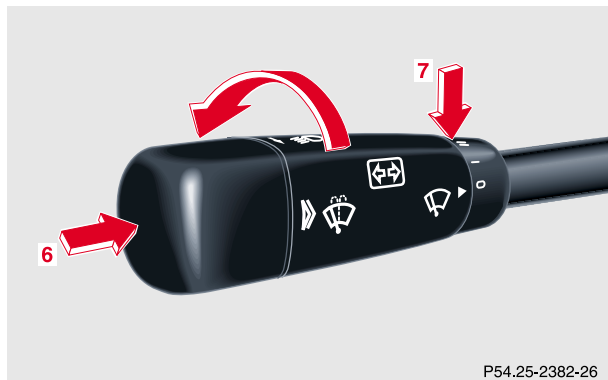

P54.25-2382-26

- 6 Press switch briefly:  
Single wipe without washer fluid  
(select only if windshield is wet).  
  
Push switch past resistance point:  
Windshield washer system, windshield wipers.  
  
See page 302 for instructions on filling the  
windshield washer reservoir.
- 7 Windshield wipers

- 0 Off
- I Intermittent wiping  
  
Vehicles with optional rain sensor:  
One initial wipe, pauses between wipes are  
automatically controlled by a rain sensor  
monitoring the wetness of the windshield. This  
will not occur with a front door open.

Notes:

With switch in this position, one wipe occurs  
when turning the electronic key in starter switch  
from position 0. This will not occur with a front  
door open.

Do not leave in intermittent setting when vehicle  
is taken to an automatic car wash or during  
windshield cleaning. Wipers will operate in  
presence of water spray at windshield, and  
wipers may be damaged as a result.

- II Normal wiper speed
- III Fast wiper speed

## Combination switch

136

**Blocked windshield wipers**

If the windshield wipers become blocked (for example, due to snow), switch off the wipers.

For safety reasons before removing ice or snow, remove electronic key from starter switch. Remove blockage.

Activate combination switch again (electronic key in starter switch position 1).

**Emergency operation of windshield wipers**

In case of windshield wiper malfunction in switch positions I or III, turn combination switch to wiper setting II. Have the system checked at your authorized Mercedes-Benz Center as soon as possible.

**Windshield wipers smear**

If the windshield wipers smear the windshield, even during rain, activate the washer system as often as necessary. The fluid in the washer reservoir should be mixed in the correct ratio.

See page 302 for instructions on filling up the windshield washer reservoir.

**Windshield and headlamp washer fluid mixing ratio**

For temperatures above freezing:  
MB Windshield Washer Concentrate “S” and water.

1 part “S” to 100 parts water  
(40 ml “S” to 1 gallon water).

For temperature below freezing:

MB Windshield Washer Concentrate “S” and commercially available premixed windshield washer solvent/antifreeze

1 part “S” to 100 parts solvent  
(40 ml “S” to 1 gallon solvent).

## Hazard warning flasher switch

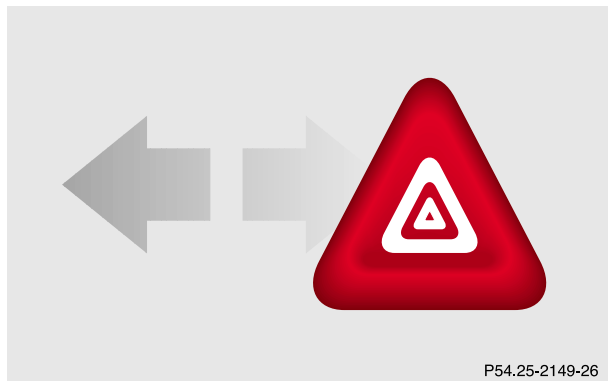

The hazard warning flasher can be activated either manually via the switch located in the dashboard, or it is activated automatically at the time an airbag is deployed.

To activate hazard warning flasher, press switch once. To deactivate, press switch again.

If hazard warning flasher was activated automatically, press switch twice to deactivate.

Note:

With the hazard warning flasher activated, the combination switch in position for either left or right turn, and the electronic key in starter switch position 1 or 2, only the respective left or right side turn signals will operate.

## Climate control

138

## Climate control (model C 240)

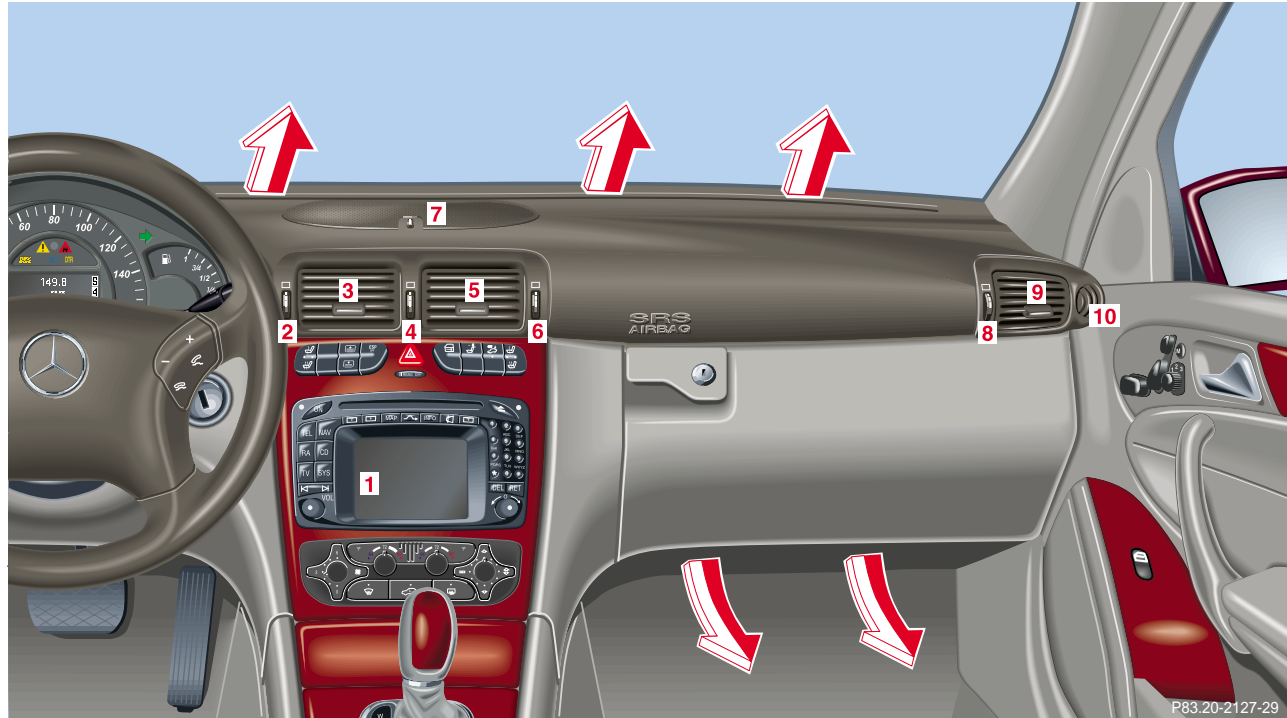

- 1 Display and controls
- 2 Air volume control for left center air outlet
- 3 Center air outlet, left, adjustable
- 4 Thumbwheel for adding outside air at air outlets for center, left and right sides, as well as dashboard top center and rear passenger compartment
- 5 Center air outlet, right, adjustable
- 6 Air volume control for right center air outlet
- 7 Air volume control and air outlet on dashboard top center
- 8 Air volume control for side air outlet
- 9 Side air outlet, adjustable
- 10 Side defroster outlet, fixed



## Climate control

140

## Display and controls

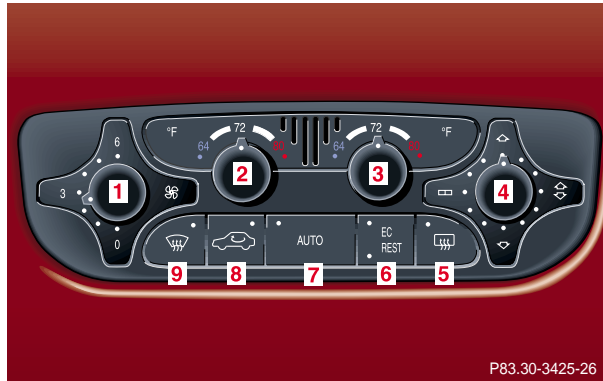

- 1 Air volume
- 2 Temperature control, left
- 3 Temperature control, right
- 4 Air distribution control switch

- 5 Rear window defroster, see page 157
- 6 Economy mode, see page 145  
Residual engine heat utilization, see page 145
- 7 Air distribution and air volume (automatic)
- 8 Air recirculation, see page 153
- 9 Defrosting, see page 143

**Important!**

This vehicle is equipped with an air conditioning system that uses R-134a (HFC: hydrofluorocarbon) as a refrigerant. Repairs should always be performed by a qualified technician, and refrigerant should be collected in a recovery system for recycling.

## Climate control

The system is always at operational readiness, except when manually switched off.

The climate control only operates with the engine running.

The temperature selector should be left at the desired temperature setting. The temperature selected is reached as quickly as possible.

The system will not heat or cool any quicker by setting a higher or lower temperature.

The desired interior temperature can be selected separately for the left and right side of the passenger compartment.

The climate control removes considerable moisture from the air during operation in the cooling mode. It is normal for water to drip on the ground through ducts in the underbody.

The air conditioning will not engage (no cooling) if the economy mode **EC** is selected, see page 145.

Notes:

Do not obstruct the air flow by placing objects on the air flow-through exhaust slots below the rear window.

Also keep the air intake grill in front of the windshield free of snow and debris.

The storage compartment between the front seats can be ventilated. See page 158 for notes on ventilating the storage space under the armrest in the center console.

The air conditioner switches itself off for its own protection if refrigerant is lost. No cooling will then take place. Economy mode **EC** cannot be switched off. Have the air conditioner checked by a Mercedes-Benz Center should this happen.

## Dust filter

Nearly all dust particles and pollen are filtered out before outside air enters the passenger compartment through the air distribution system.

## Climate control

142

**Basic setting – automatic mode**

Press **AUTO** button. Air volume and distribution are controlled automatically.

Set the left and right temperature to 72°F (22°C). This provides for comfortable conditions in the vehicle.

Heating mode:

To lower headroom temperature, use thumbwheel (4, page 138).

Air conditioning mode:

Open air outlets at dashboard top center (7, page 138) for an even air distribution.

**Special settings** (use only for short duration)

**Air distribution and air volume, manual**

Press **AUTO** button. The indicator lamp in the button will go out.

Select any of the six air volume speeds and the air distribution.

Air distribution, manual:



Air from the center, side, dashboard top center and rear passenger compartment air outlets.



Air from the windshield, side defroster and rear passenger compartment air outlets.





Air from the center, side, footwell, rear footwell and rear passenger compartment air outlets.

To return to automatic mode:

Press the **AUTO** button. The indicator lamp in the button illuminates.

## Defrosting

Press the  button. The indicator lamp in the button illuminates.

Switch off air recirculation, if selected. Press button , the indicator lamp in the button will go out.

Close center air outlets.

Turn wheels (8, page 138) up to open left and right side air outlets (9, page 138). Adjust side air outlets upward.

Pressing the switch again returns the system to the previous setting.

## Windows fogged up on the inside

Switch off the economy mode, if selected. Press button . The indicator lamp in the button will go out.

Switch off air recirculation, if selected. Press button . The indicator lamp in the button will go out.

Press the  button. The indicator lamp in the button illuminates.

Increase temperature setting.

Open the side air outlets (9, page 138) and direct them onto the side windows.

## Climate control

144

**Windshield fogged up on the outside**

Switch on the windshield wiper.

Close air outlet at dashboard top center.

Switch to manual mode.

Turn air distribution switch to position  or .

**Air recirculation**

Select air recirculation:

Press button  briefly. The indicator lamp in the button illuminates.

To switch off the air recirculation:

Press button  briefly. The indicator lamp in the button will go out.

Switching on air recirculation and activating convenience closing of power windows and sliding/pop-up roof:

Press button  for more than 2 seconds, the side windows and the sliding/pop-up roof will be closed. The indicator lamp in the button lights up.

Switching off air recirculation and activating convenience opening:

Press button  for more than 2 seconds, the side windows and the sliding/pop-up roof return to the position they were in before closing.

A window or the sliding/pop-up roof opened manually after convenience closing will no longer be returned to the position it was in before closing when convenience opening is selected.

The system automatically switches from air recirculation to fresh air:

- after 30 minutes if the outside temperature is above about 40°F (5°C),
- after 5 minutes if the outside temperature is below about 40°F (5°C),
- after 5 minutes if economy mode  is selected.

The system switches automatically to air recirculation at high outside temperatures. A quantity of outside air is added after about 30 minutes.

If the windows should fog up from the inside, switch from recirculated air back to fresh air.

## Climate control - OFF/ON

To switch the climate control off, set the air volume control switch to position 0.

The fresh air supply to the vehicle interior is shut off.

While driving, use this setting only temporarily, otherwise the windshield could fog up.

To switch the climate control on again, set air volume control switch to any speed.

## Economy mode

The function of this setting corresponds to the automatic mode. However, because the air conditioning compressor will not engage (fuel savings), it is not possible to air condition in this setting.

Press **EC** button to activate. The indicator lamp in the button illuminates.

Press **EC** button once again to return to the previous setting.

## Important!

In the **EC** mode the windows could fog up on the inside. Switch off **EC** mode.

## Residual engine heat utilization

With the engine switched off, it is possible to continue to heat or ventilate the interior for a short while. Air volume and distribution are controlled automatically.

To select:

Turn the electronic key in starter switch to position 1 or 0 or remove it altogether.

Press button **REST**. The indicator lamp in the button illuminates.

This function selection will not activate if the battery level is insufficient.

The function switches off automatically:

- if the electronic key in starter switch is turned to position 2,
- after approximately 30 minutes,
- if the battery voltage drops.

Automatic climate control

Automatic climate control

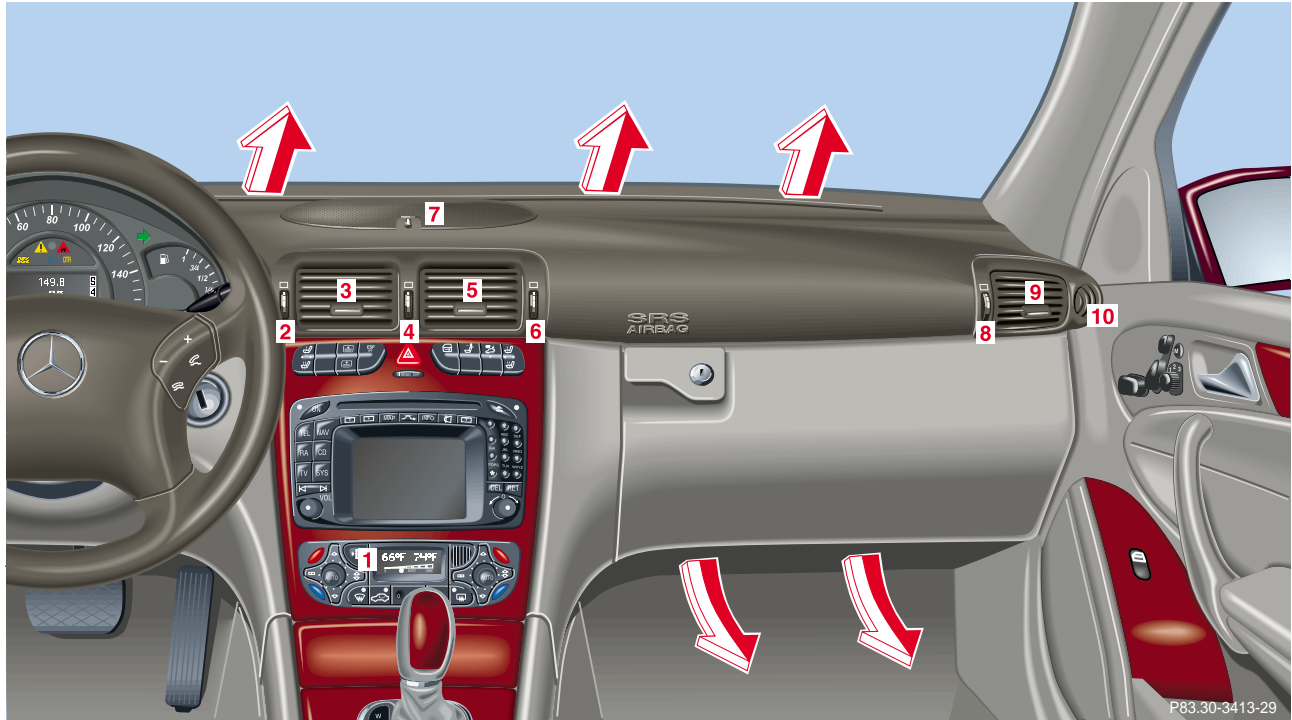

- 1 Display and controls
- 2 Air volume control for left center air outlet
- 3 Center air outlet, left, adjustable
- 4 Thumbwheel for adding outside air at air outlets for center, left and right sides, as well as dashboard top center and rear passenger compartment
- 5 Center air outlet, right, adjustable
- 6 Air volume control for right center air outlet
- 7 Air volume control and air outlet on dashboard top center
- 8 Air volume control for side air outlet
- 9 Side air outlet, adjustable
- 10 Side defroster outlet, fixed



## Automatic climate control

148

## Display and controls



- 1 Temperature control, left, lowering
- 2 Temperature control, left, raising
- 3 Air distribution control switch left (automatic, manual operation)
- 4 Activated charcoal filter, see page 154
- 5 Display
- 6 Air distribution control switch right (automatic, manual operation)

- 7 Temperature control, right, raising
- 8 Temperature control, right, lowering
- 9 Rear window defroster, see page 157
- 10 Economy mode, see page 155  
Residual engine heat utilization, see page 156
- 11 Air volume control +  
switch on system
- 12 Air volume control -  
switch off system
- 13 Air recirculation, see page 153
- 14 Defrosting, see page 152

**Important!**

This vehicle is equipped with an air conditioning system that uses R-134a (HFC: hydrofluorocarbon) as a refrigerant. Repairs should always be performed by a qualified technician, and refrigerant should be collected in a recovery system for recycling.

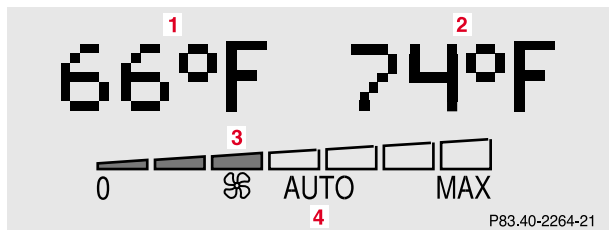

- 1 Temperature, left
- 2 Temperature, right
- 3 Air volume
- 4 Automatic mode is selected

## Automatic climate control

The system is always at operational readiness, except when manually switched off.

The automatic climate control only operates with the engine running.

The temperature selector should be left at the desired temperature setting. The temperature selected is reached as quickly as possible.

The system will not heat or cool any quicker by setting a higher or lower temperature.

The desired interior temperature and air distribution can be selected separately for the left and right side of the passenger compartment.

The automatic climate control removes considerable moisture from the air during operation in the cooling mode. It is normal for water to drip on the ground through ducts in the underbody.

The air conditioning will not engage (no cooling) if the economy mode **EC** is selected, see page 155.

## Automatic climate control

150

Notes:

Do not obstruct the air flow by placing objects on the air flow-through exhaust slots below the rear window.

Also keep the air intake grill in front of the windshield free of snow and debris.





The storage compartment between the front seats can be ventilated. See page 158 for notes on ventilating the storage space under the armrest in the center console.

The air conditioner switches itself off for its own protection if refrigerant is lost. No cooling will then take place. Economy mode  cannot be switched off. Have the air conditioner checked by a Mercedes-Benz Center should this happen.

### Dust filter

Nearly all dust particles and pollen are filtered out before outside air enters the passenger compartment through the air distribution system.

### Basic setting – automatic mode

Briefly press left or right  button. The ,  and  symbols will no longer be visible.

The economy mode and air recirculation functions will be switched off. The automatic blower will be activated at the same time.

Set the temperature switches on the left and right to 72°F (22°C). This provides for comfortable conditions in the vehicle.

Heating mode:



To lower headroom temperature, use thumbwheel (4, page 146).



Air conditioning mode:

Open air outlets at dashboard top center (7, page 146) for an even air distribution.



**Special settings** (use only for short duration)

### **Air distribution, manual**

Press left or right **AUTO** button. The ,  and  symbols are visible. Turn the button to select the air distribution desired.

-  Air from the center, side, dashboard top center and rear passenger compartment air outlets.
-  Air from the windshield, side defroster and rear passenger compartment air outlets.
-  Air from the center, side, footwell, rear footwell and rear passenger compartment air outlets.

To return to automatic mode:

Press left or right **AUTO** button. The ,  and  symbols will no longer be visible.



### **Air volume, manual**

Seven blower speeds are available.

Press right  or left **0** side of air volume control switch until the requested blower speed is attained.

The display “AUTO” disappears and the automatic mode is switched off. The selected blower speed is shown in the display.

To return to automatic mode:

Press left or right **AUTO** button. The ,  and  symbols will no longer be visible.

**Automatic climate control**

152

**Defrosting****Windows fogged up on the inside**

Press the  button. The indicator lamp in the button illuminates.

Switch off air recirculation, if selected. Press button , the indicator lamp in the button will go out.

The fan is set to a higher speed and the warm air is directed to the defroster and windshield air outlets.



Pressing the switch again returns the system to the previous setting.

**Windshield fogged up on the outside**

Switch on the windshield wiper.

Close air outlet on dashboard top center (7, page 146).

Switch to manual mode.

Turn air distribution control switch to position  or .

## Air recirculation

Select air recirculation:

Press button  briefly. The indicator lamp in the button illuminates.

To switch off the air recirculation:

Press button  briefly. The indicator lamp in the button will go out.

Switching on air recirculation and activating convenience closing of power windows and sliding/pop-up roof:

Press button  for more than 2 seconds, the side windows and the sliding/pop-up roof will be closed. The indicator lamp in the button lights up.

Switching off air recirculation and activating convenience opening:

Press button  for more than 2 seconds, the side windows and the sliding/pop-up roof return to the position they were in before closing.

A window or the sliding/pop-up roof opened manually after convenience closing will no longer be returned to the position it was in before closing when convenience opening is selected.

The system automatically switches from air recirculation to fresh air:

- after 30 minutes if the outside temperature is above about 40°F (5°C),
- after 5 minutes if the outside temperature is below about 40°F (5°C),
- after 5 minutes if economy mode  is selected.

The system switches automatically to air recirculation at high outside temperatures. A quantity of outside air is added after about 30 minutes.

If the windows should fog up from the inside, switch from recirculated air back to fresh air.

## Automatic climate control

154

**Activated charcoal filter**

An activated charcoal filter markedly reduces bad odors and removes pollutants from air entering the passenger compartment.

To select, press  button. The indicator lamp in the button illuminates.



To cancel, press button. The indicator lamp in the button goes out.

The system switches automatically to the air recirculation mode, if the carbon monoxide (CO) or nitrogen oxides (NO<sub>x</sub>) concentration of the outside air increases beyond a predetermined level.



The automatic air recirculation mode does not function if economy mode  is selected or if the outside temperature has fallen below 40°F (5°C).

The activated charcoal filter should be switched off when windows fog up on the inside, or if the passenger compartment needs to be quickly heated or cooled down.

Switching on the activated carbon filter and activating convenience closing of power windows and sliding/pop-up roof:

The indicator lamp in the  button is off. Press button  for more than 2 seconds, the side windows and the sliding/pop-up roof will be closed. The indicator lamp in the button lights up.

Switching off activated carbon filter and activating convenience opening:

The indicator lamp in the  button is on. Press button  for more than 2 seconds, the side windows and the sliding/pop-up roof return to the position they were in before closing.

A window or the sliding/pop-up roof opened manually after convenience closing will no longer be returned to the position it was in before closing when convenience opening is selected.

## Economy mode

The function of this setting corresponds to the automatic mode. However, because the air conditioning compressor will not engage (fuel savings), it is not possible to air condition in this setting.

Press **EC** button to activate. The indicator lamp in the button illuminates.

Press **EC** button once again to return to the previous setting.

### Important!

In the **EC** mode the windows could fog up on the inside. Switch off **EC** mode.

## Automatic climate control - OFF/ON

To switch the climate control off, set the air volume control switch to position 0.

The fresh air supply to the vehicle interior is shut off.

While driving, use this setting only temporarily, otherwise the windshield could fog up.

To switch the climate control on again, press the **AUTO** or  button, or set air volume control switch to any speed.



## Automatic climate control

156

### Residual engine heat utilization

With the engine switched off, it is possible to continue to heat or ventilate the interior for a short while. Air volume and distribution are controlled automatically.

To select:

Turn the electronic key in starter switch to position 1 or 0 or remove it altogether.

Press button **REST**. The indicator lamp in the button illuminates.

This function selection will not activate if the battery level is insufficient.

The function switches off automatically:

- if the electronic key in starter switch is turned to position 2,
- after approximately 30 minutes,
- if the battery voltage drops.

## Rear window defroster

Turn the electronic key in starter switch to position 2.

To select:

Press the  button in the control panel of the automatic air conditioner. The indicator lamp in the button illuminates.

To cancel:

Press the  button in the control panel of the automatic air conditioner. The indicator lamp in the button goes out.

Note:

Heavy accumulation of snow and ice should be removed before activating the defroster.

The rear window defroster uses a large amount of power. To keep the battery drain to a minimum, turn off the defroster as soon as the rear window is clear.

The defroster is automatically turned off after approximately 6–17 minutes of operation depending on the outside temperature and vehicle speed.

If several power consumers are turned on simultaneously, or the battery is only partially charged, it is possible that the defroster will automatically turn itself off. When this happens, the indicator lamp inside the switch starts blinking.

As soon as the battery has sufficient voltage, the defroster automatically turns itself back on.

## Automatic climate control

158

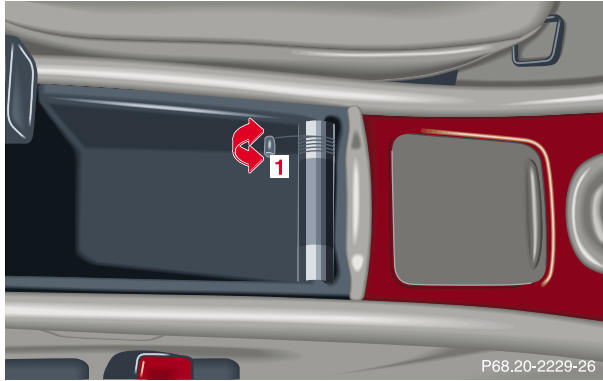
**Front center console storage compartment  
ventilation**

The front center console compartment has its own air outlet.

To open: Raise lever (1).

To close: Lower lever (1).

The air volume is dependent on the setting of:

- air distribution control,
- air volume control,
- air outlets in the dashboard.

The air temperature is about the same as that of the dashboard air outlets. It cannot be regulated separately.

Notes:

The compartment can get very warm due to its confined space. When storing heat sensitive objects in the compartment, close the air outlet while heating the passenger compartment.

Do not allow articles to obstruct the air outlet in the storage compartment.

## Rear passenger compartment adjustable air outlets



- 1 Center air outlet, left
- 2 Air volume control for center air outlets  
To open: Turn the wheel upward.
- 3 Center air outlet, right

Note:

The temperature at the air outlets for the rear passenger compartment (1 and 3) is the same as at the dashboard center air outlets.

### Audio and telephone operation

These instructions are intended to help you become acquainted with your Mercedes-Benz audio system. They contain useful tips and a detailed description of the user functions.

#### Warning!

**In order to avoid distraction which could lead to an accident, system settings should be entered with the vehicle at standstill and systems should be operated by the driver only when traffic conditions permit. Always pay full attention to traffic conditions first before operating system controls while driving.**

**Bear in mind that at a speed of just 30 mph (approximately 50 km/h), your car is covering a distance of 50 feet (approximately 14 m) every second.**

### Operating safety

#### Warning!

**Any alterations made to electronic components can cause malfunctions.**

**The radio, cassette deck, CD changer<sup>1</sup> and telephone<sup>1</sup> are interconnected. Therefore, when one of the components is defective or has not been removed/replaced properly this may impair the function of other components.**

**These malfunctions might seriously impair the operating safety of your vehicle.**

**We recommend that you have any service work or alterations to electronic components done at an authorized Mercedes-Benz Center.**

#### 1 Optional equipment

Dolby and the double-D symbol  are trademarks of Dolby Laboratories Licensing Corporation. The Dolby noise reduction system is manufactured under licence from Dolby Laboratories Licensing Corporation.

## Operating and display elements



- 1 On/off, volume, see page 163
- 2 Telephone mode selector, see page 177
- 3 Seek tuning, see page 167,  
Track search (tape), see page 171,  
Skipping tracks (CD), see page 175  
Manual repeat dialing (telephone), see page 180
- 4 Radio mode selector, see page 166
- 5 Manual tuning, see page 167 and 167  
Fast Forward/Reverse (tape), see page 171  
Fast Forward/Reverse (CD), see page 176  
Telephone book, see page 178
- 6 CD mode selector, see page 175
- 7 Tape mode selector, see page 169

## Audio system

## 162

- 8** Display panel  
The cassette slot is located behind the display panel.  
For notes on playing cassettes, see page 169
- 9** Alpha-numeric keypad for  
station storage and frequency entry, see page 169  
optional telephone, see page 177  
Tape eject, see page 170  
Tape track select, see page 171  
Dolby, see page 172  
CD track access, see page 177
- 10** Scan tuning (Radio, see page 167)  
Tape track search, see page 171  
CD, see page 167
- 11** Function button, see page 169 and 177
- 12** Soft keys for  
radio band selection, see page 166  
tone controls, see page 164  
scan, see page 167
- 13** Tape eject, see page 169

## Button and soft key operation

In these instructions, the alpha-numeric keypad (right side of radio face) and the function buttons (left side of the radio face) are referred to as “buttons” and the four keys under the display are referred to as “soft keys”

Note:

Do not press directly on the radio display face.

## Operation

### Switching on and off

Press the control knob  .

The system is switched off when the electronic main key in the starter switch is turned to position 0 or removed. The radio is switched on again when the electronic main key in the starter switch is turned to position 1 or 2.

Note:

The system can also be switched on separately with the electronic main key removed, but will switch itself off automatically after half an hour to conserve vehicle battery power.



## Audio system

164

**Adjusting the volume**

Turning the control knob clockwise will increase the volume, counterclockwise will decrease the volume.

Note:

The volume setting can be selected separately for the telephone, audio system and voice recognition system.

**Audio functions**

The “AUD” key is used to select the BASS, TREBLE, FADER and BALANCE functions. Settings for bass and treble are stored separately for the radio, cassette and CD modes. Tone level settings are identified by the vertical bars. The center (flat) setting is shown by one longer bar in the center of the display.

**Bass**

Press the “AUD” key repeatedly until “BASS” appears on the display.

Press the “+” key to increase or the “-” key to decrease the level.

Pressing the “+” and “-” keys simultaneously resets the Bass to its center (flat) level.

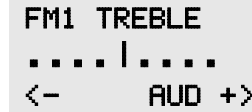
**Treble**

Press the “AUD” key repeatedly until “TREBLE” appears on the display.

Press the “+” key to increase or the “-” key to decrease the level.

Pressing the “+” and “-” keys simultaneously resets the Treble to its center (flat) level.

## Fader



FM FADER  
.....|.....  
<F EXT AUD R>

Press the “AUD” key repeatedly until “FADER” appears on the display. Press the “R” key to move the sound to the rear speakers or the “F” key to move the sound to the front speakers.

Pressing the “F” and “R” keys simultaneously resets the Fader to its center level.

## Balance



FM BALANCE  
.....|.....  
<L EXT AUD R>

Press the “AUD” key repeatedly until “BALANCE” appears on the display.

Press the “L” key to move the sound to the left speakers or the “R” key to move the sound to the right speakers.

Pressing the “L” and “R” keys simultaneously resets the Balance to its center level.

## Centering all audio functions



RESET

Push and hold down the “AUD” key. All audio functions (bass, treble, balance and fader) are set to center or flat positions, and the volume is adjusted to a preset level. “RESET” appears on the display.

## Audio system

166

**Audio system tone level selection**

SOUND  
DRIVER  
DRV SP AMB OFF

To select the tone level settings for radio, cassette, and CD operation press the key “AUD”. The tone level settings menu is now

displayed. Press key “EXT”, and “SOUND” appears on the display.

Press the key “DRV” to adjust the sound to the “Driver” position.

The key “SP” is for “Speech”, optimizing the sound for spoken language.

The key “AMB” offers “Ambience”, a three-dimensional sound.

The key “OFF” switches off the tone level setting selection.

**Radio mode****Selecting radio mode**

Press  button.

**Selecting the band**



FM5 ST  
95.5 MHz  
AM WB AUD AS

Press the key located below the desired band. The band selected is shown in the top line of the display.

Frequency ranges:	FM	87.9 -107.9 MHz
	AM	530 -1710 kHz
	WB	approx.162 MHz

## Manual tuning

AM4  
880 kHz  
FM WB AUD AS

Press either the  or  button. Step-by-step station tuning in ascending or descending order of frequency will take place.

The first three tuning steps will take place without muting. The radio will then be muted and high-speed tuning will take place until the button is released. The following tuning intervals will be shown on the display:







FM 200 kHz  
AM 10 kHz  
WB Channels 1-7

## Seek tuning

Press either the  or  button. The radio will tune to the next receivable station.

## Scan tuning

FM1  
95.5 MHz  
AM WB AUD AS

Press the  button. Each strongly receivable station on the band selected will be tuned in for 8 seconds. The first scan will tune only the stations with a high signal strength. The second scan will tune every receivable station. By pressing either the , , ,  buttons or the  button the scan mode can be cancelled.

## Audio system

168

**Weather Band**

Press the “WB” key. The last weather band station is tuned in.

Use buttons **1** - **7** PCRS to select a different station. If the station cannot be received, the next available station is selected automatically.

Press button **▶** or **◀**. The next available station is tuned in. The message “WB NONE” appears if no station can be received.

**Station memory**

Ten stations each in the AM and FM bands can be stored via the alpha-numeric keypad. The **0** OPR button corresponds to location 10. Weatherband (WB) channels 1 to 7 are preset at the factory and can be retrieved via the alpha-numeric keypad, but cannot be changed.

**Storing stations automatically (Autostore)**

```
FM  
SEARCH  
AM WB AUD AS
```

Press the “AS” key until the word “SEARCH” is displayed. The ten strongest stations are stored automatically, with **1** having the strongest signal.

Note:

Autostore memory is in addition to the regular station memory. Previously stored stations are not erased.

Briefly press “AS” to leave the Autostore and return to manual presets. Press “AS” again to call up Autostore.

## Storing stations

Hold the desired number button **1** - **0** OPR down for approximately 2 seconds. The currently displayed frequency is stored on the selected station button. The storage procedure is confirmed by a short signal tone.

## Retrieving a station from memory

Press the desired station button **1** - **0** OPR.

## Direct frequency input (AM and FM only)



Select the band. Press the **\*** button and enter the desired frequency using the alpha-numeric keypad **1** - **0** OPR. Frequencies outside of

the frequency ranges (frequencies specified on page 166) will not be accepted. The frequency input mode is cancelled if no button is pressed within 4 seconds.

## Cassette mode

### Playing cassettes

Press the **TAPE** button. When the **EJ** button is pressed, the display folds down and the cassette slot becomes visible. Push the cassette gently into the slot until it engages. The cassette will be pulled in automatically.

Note:

Do not press directly on the display face.

Return the display panel to its normal position by folding it back up and pressing gently on the display frame to lock in place.

### Important!

If the display is in the down position for more than 20 seconds, 2 successive beeps will be heard. This will continue at 5 second intervals until the display is returned to its normal position.

## Audio system

170



TAPE  
SIDE 1  
TRK NR AUD SB

The system will switch to cassette mode. Track 1 will be played and “SIDE 1” displayed. Track 1 is the side of the cassette which is facing

upwards. The cassette deck will automatically detect the type of tape and switch the equalization automatically. A cassette symbol on the display indicates that a tape is in the mechanism. This symbol appears in all modes except cassette mode.

The cassette will not be ejected when the system is switched off or another mode is selected.

If a cassette is in the mechanism, cassette mode can be selected by using the **TAPE** button.

If no cassette has been inserted, the display will show “NO TAPE”.

**Cassette eject**

Press the **EJ** button. The display will fold down and the cassette will be ejected. Remove the cassette, then fold the display back up manually. The system will switch back to radio mode automatically.

Notes:

The cassette will not be ejected when the system is switched off. If a cassette is not ejected, continue to hold the **EJ** button for at least 5 seconds to eject the cassette.

**Important!**

If the display is in the down position for more than 20 seconds, 2 successive beeps will be heard. This will continue at 5 second intervals until the display is returned to its normal position.

## Track selection

```
TAPE  
SIDE 1  
TRK NR AUD SB
```

Press the track selection “TRK” key. The current track will be displayed as “SIDE 1” or “SIDE 2”. The track will be changed automatically at the end of the tape.

## Track search forward/backward

```
TAPE  
SEEK FWD  
TRK NR AUD SB
```

Press the  button. “SEEK FWD” will be shown on the display and the track search will run the tape forward to the start of the next track.

```
TAPE  
SEEK RWD  
TRK NR AUD SB
```

Press the  button. “SEEK RWD” will be shown on the display and the track search will run the tape backward to the start of the track currently playing. Track search can be interrupted by pressing the same button again.

Note:

The beginning of a track can only be located if there is a break of at least 4 seconds between tracks.

## Fast forward/reverse

```
TAPE  
FORWARD  
TRK NR AUD SB
```

Press the  button. “FORWARD” will appear on the display and fast forward will start.

```
TAPE  
REWIND  
TRK NR AUD SB
```

Press the  button. “REWIND” will appear on the display and fast reverse will start.

Fast forward/reverse is stopped by pressing the same button again, or it will stop automatically at the beginning or the end of the tape. The track will automatically change at the end or beginning of the tape and play will begin.



## Audio system

172

## Scanning

```
TAPE SC
SEEK FWD
TRK NR AUD SB
```

Press the **SC #** button. “SEEK FWD” will appear on the display. Each track will be played for 8 seconds in ascending order. The search

will stop if any of the **SC #**, **▲**, **▼**, **▶**, **◀** buttons are pressed.

## Skipping of blank sections (Skip-Blank)

```
FM BALANCE
.....|.....
<L EXT AUD R>
```

Press the “SB” key. The Skip-Blank function is switched on or off. When switched on, the “SB” on the display is highlighted.

With the “SB” function activated and no sound signal received for approximately 10 to 15 seconds, the tape will fast forward to the next sound signal.

Dolby NR<sup>1</sup> (noise reduction system)

```
TAPE BASS
.....|.....
<- NR AUD +>
```

To enable optimum sound reproduction of cassettes recorded using the Dolby B system, press the “NR” key so the “NR” on the display is highlighted. To turn off Dolby B noise reduction, press the “NR” key so the “NR” on the display is not highlighted.

- 1 Dolby and the double-D symbol **DD** are trademarks of Dolby Laboratories Licensing Corporation. The Dolby noise reduction system is manufactured under licence from Dolby Laboratories Licensing Corporation.

## CD mode

### General notes on CD mode

Should excessive temperatures occur while in CD mode, “CD TEMP HIGH” will appear on the display and muting will take place. The unit will then switch back to radio mode until the temperature has decreased to a safe operating level.

Should temperatures occur while in CD mode which are too low, “CD TEMP LOW” will be displayed, but the CD will play. It will be sensitive to skipping if you are driving over rough roads.

Handle CDs carefully to prevent interference during playback.

Avoid fingerprints and dust on CDs. Do not write on the CDs or apply any label or other material or devices to the CDs.

Clean CDs from time to time with a commercially available cleaning cloth. No solvents, anti-static sprays, etc. should be used.

Replace the CD in its container after use. Protect CDs from heat and direct sunlight.

### Warning!

**The CD changer<sup>1</sup> is a Class 1 laser product. There is a danger of invisible laser radiation if the cover is opened or damaged.**

**Do not remove the cover. The CD changer<sup>1</sup> does not contain any parts which can be serviced by the user. For safety reasons, have any service work which may be necessary performed only by qualified personnel.**

1 Optional equipment

## Audio system

174

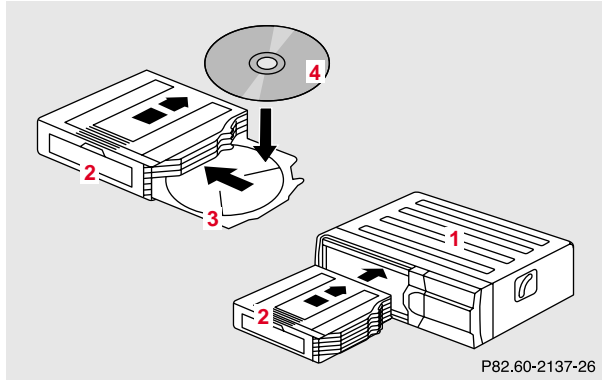
CD changer<sup>1</sup> installed

- 1 CD changer
- 2 CD magazine
- 3 CD tray
- 4 CD

If a CD changer<sup>1</sup> is installed, it can be operated from the front control panel of the radio. A loaded magazine must be installed for CD playing.

1 Optional equipment

## Loading/emptying the CD magazine

Slide the changer door to the right until it latches open and press the eject button . The magazine will be ejected. Remove the magazine. Pull out the CD tray to its stop and place the CDs in the recess of the tray, label side up. Push the tray into the magazine in the direction shown by the arrow. Insert the loaded magazine into the changer.

**Important!**

Close the door after the magazine has been inserted.

## Playing CDs

Press the **CD** button. When the changer is used for the first time after removing/inserting a magazine, play begins at CD 1 track 1. After that, the CD most recently played will start at the point where it was last switched off. CDs stored in the magazine can be selected by using the station preset buttons 1-6.

```
CD1
TRACK 1
RDM RPT AUD T
```

The magazine slot number of the selected CD will be displayed after “CD”. The number of the track being played will be displayed after “TRACK”.

```
CD1
NO CD3
RDM RPT AUD
```

If there is no CD in the selected magazine slot, “NO CD” and the corresponding slot number will be displayed

(e.g. “NO CD3”). After the last track on a CD has been played, the next CD will automatically be selected and played.

## Skipping tracks forward/backward

Press the **▶** button. The next track on the CD will be played.

Press the **◀** button. If the track has been playing for more than 10 seconds, it will revert to the start of that track. If it has been playing for less than ten seconds it will revert to the preceding track. To skip several tracks, the respective button must be pressed until the desired track is reached. If the beginning or end of the CD is reached during the search, the first or last track will be played.

## Audio system

176

**Fast forward/reverse**

Press and hold the  button for audible fast forward.

Press and hold the  button for audible reverse.









CD3  
T01 / 02:46  
RDM RPT AUD T

The search will stop when the button is released. The played time of the track will be displayed during the search.

The search mode will cancel if the beginning or end of the CD is reached.

**Scanning**

Press the  button. Each track will be played for 8 seconds in ascending order. The search will stop at the current track if any of the , , , ,  buttons are pressed.

**Random play/repeat function**

The tracks of the current CD are played in random order when the random feature (RDM) is selected. Press the “RDM” key to switch on. “RDM” will be highlighted. Press “RDM” again to switch off.



CD1  
TRACK 10  
RDM RPT AUD T

When the repeat function (RPT) has been selected, a particular track can be played for as many times as desired.

Press the “RPT” key to switch on. “RPT” will be highlighted. Press “RPT” again to switch off.

Note:

Both functions cannot be used simultaneously.

## Direct track selection

Tracks can be selected directly using the buttons on the alpha-numeric keypad. Press the **\*** function button, followed by the track number.

## Track and time display



Pressing the function button “T” displays the track number and elapsed playing time of the track being played.

Pressing the function button “T” again displays the total number of tracks and the total playing time of the CD being played. After 8 seconds the display switches back to the main display.

## Telephone operation

Various functions of the Mercedes-Benz integrated portable cellular telephone<sup>1</sup> can be performed and displayed via the system. Further instructions for operating the integrated telephone can be found in the operation guide for the telephone<sup>1</sup>.

## Switching the telephone on and off

Switching on:

Press the **TEL** button.

Switching off:

Press and hold the **TEL** button until “PHONE OFF” appears on the display.

1 Optional equipment

## Audio system

178

**Adjusting the volume**

Turning the control knob clockwise will increase the volume, counterclockwise will decrease the volume.

Note:

The volume setting can be selected separately for the telephone, audio system and voice recognition system.

**Entering telephone number and starting dialing process**

Enter the desired telephone number using the alphanumeric keypad. The number can have up to 32 digits, but only 13 of these can be

displayed. The dialing process is started by pressing the “SND” key. The entered number can be corrected using the “CLR” key.

Press the “CLR” key briefly, and the last digit will be deleted.

Press and hold the “CLR” key, and the complete number will be deleted.

**Calling up the telephone book**

The numbers stored in the telephone number memory can be called up via either name or number entries. The memory contents from the portable telephone must contain numbers and names in at least one memory location and the portable telephone must be connected to the vehicle coil cord in order to call up the telephone book. Refer to the “Memory download” section of the cellular telephone operation guide for more information.

**Switching between name search and number search**

Press “ABC” key - Name search

Press “NUM” key - Number search

## Searching and selecting telephone book entries by name



S \_ \_ \_ \_  
BAUER  
SND NUM CLR END

Press the “ABC” key. The current name is shown on the display. The stored entries in alphabetical order can be selected using the **▲** or

**▼** button. By pressing the **▶** or **◀** button, the stored entries can be selected according to alphabetical initial letters (e.g. A-Adam, B-Brown, M-Miller).

Using the buttons **1** - **0** on the alpha-numeric keypad the stored entries can be selected according to initial letters (e.g. B-Brown, press button **2** twice).

Note:

Some signs and symbols cannot be displayed.

## Searching and selecting telephone book entries by number



S \_ \_ \_ \_ M12  
7248711353  
SND ABC CLR END

Press the “NUM” key. The current number is shown on the display. The stored entries can be selected in numerical order using the **▲** or **▼**

button. By pressing the **▶** or **◀** button, the stored entries can be selected in increments of 5 (e.g. Entry no. 2, Entry no. 7, etc.).

## Placing a call



S \_ \_ \_ \_  
5551212  
SND CLR END





When a number or a name has been selected using the method described above, press the “SND” key.



## Audio system

180

**Manual repeat dialing (redial)**

The last number entered can be re-selected by pressing the “SND” key once, and the call can be placed by pressing the “SND” key a second time. The last dialed telephone number is shown on the display. Using the , ,  or  button, the numbers stored in the re-dial memory of the telephone can be selected.



The abbreviation L and the number in the memory are shown in the top line of the display.

**Automatic repeat dialing (redial)**

If no call can be placed, press the “SND” key.



“REDIAL” is shown on the display and repeated attempts will be made for the next four minutes.

**Abbreviated dialing from previously stored telephone numbers****Quick-dialing**

Enter the previously selected maximum 3-digit (1 - 999) number and press “RCL”.

The telephone number previously stored under that number will be displayed. Press the soft key “SND”. The call is set up.

**Speed-dialing**

Enter the memory location desired with buttons  - . You can enter up to 2 digits.

To correct the last digit press the soft key “CLR”.

Press the soft key “SND”. The phone number stored at this memory location will appear on the screen and the call is set up.

The abbreviation “L” and the number in the memory are shown in the top line of the display.

## Express-dialing

Press one of the number buttons **1** - **0**<sub>OPR</sub> for more than 1 second.

The phone number or the name stored at this memory location will appear on the screen.

When the call is initiated, the call time will appear on the display.

Note:

Please be aware that button **1** might already be reserved for an emergency call number, see page 183.

## Call hold feature

While on the telephone, a second call can be accepted by pressing the “SND” key. The first call will be put on hold. Press “SND” to toggle between the calls.

An additional call can be accepted after ending one of the previous calls.

## Accepting incoming call in telephone mode



With an incoming call, a ringing tone can be heard and the message “CALL” appears on the display. Press the “SND” key to answer the call.

## Accepting incoming call in tape, CD or radio mode

If the telephone is activated in the background (symbol “S” on the display), then a switch is made automatically to the telephone mode when a call is received. The audio source is muted, the ringing tone is heard and the message “CALL” appears. Press the soft key “SND” to answer the call. After the call has been terminated, the previously selected audio source is resumed.

## Audio system

182

**Terminating call**

A current call can be terminated by pressing the “END” button.

**Muting a call**

Pressing the “MUT” key will silence the call. The caller can no longer hear you. To return to the conversation, press the “MUT” key again.

**Component malfunctions**

The radio, CD changer<sup>1</sup>, and Mercedes-Benz integrated cellular telephone<sup>1</sup> are part of a fiberoptic networked system. Failure of one of the components can lead to malfunctions of the other components. Please contact your authorized Mercedes-Benz Center or call the Mercedes-Benz Client Assistance Center (in the USA) at 1-800-FOR-MERCEdes, or Customer Service (in Canada) at 1-800-387-0100 for more information in the event of a malfunction.

1 Optional equipment

## Emergency call

### Important!

If you press button **1** for more than 1 second, the number stored in memory location 1 (for example 911) will be dialed.

The 911 emergency call system is a public service. Using it without due cause is a criminal offence.

You can make an emergency call to an emergency rescue station with a mobile communications network.

The emergency call will be placed as long as the corresponding mobile communications network is available. To do this, switch the telephone on if you have not already done so.

The call will also be placed if the unlock-code is not entered.

Emergency calls may not be possible with all telephone networks or if certain network services and/or telephone functions are active. Check with your local network operating company. It may take some time to set up an emergency call.

To use this function you must ensure that the number stored in memory location 1 is the number to be dialed in case of emergency.

Note:



If an emergency call cannot be connected, the message "SYSTEM BUSY" appears.

## Interior equipment

**Power windows**

The control panel is located on the driver's door.

## 184

Switches for:

- 1** left, front
- 2** right, front
- 3** left, rear
- 4** right, rear

There are individual switches in the front passenger door and the rear doors for the respective windows.

Turn electronic key in starter switch to position 1 or 2.

Opening the windows:

Press the switch to resistance point.

Closing the windows:

Pull the switch to resistance point.

Release switch when window is in desired position.

## Express opening and closing

Press or pull switch past resistance point and release – window opens or closes completely.

To interrupt procedure, briefly press or pull switch.

If the upward movement of the window is blocked during the closing procedure, the window will stop during the last few inches before closure and open slightly.

When pulling and holding the switch to close the window, and upward movement of the window is blocked during the last few inches before closure, it will stop but not open slightly.

Note:

The power windows can also be opened and closed using the convenience opening/closing feature, see page 29.

## Warning!

**When closing the windows, be sure that there is no danger of anyone being harmed by the closing procedure.**

**In case of obstruction, the automatic reversal will not operate if a window is being closed by pulling the switch to its resistance point and holding it there, or when using the electronic main key.**

**The closing procedure can be immediately reversed by either pressing or pulling the switch, or pressing button  on the electronic main key and holding it.**

**When leaving the vehicle, always remove the electronic key from starter switch, and lock your vehicle. Do not leave children unattended in the vehicle, or with access to an unlocked vehicle. Unsupervised use of vehicle equipment can cause serious personal injury.**

## Interior equipment

186

**Blocking of rear door window operation**

The switch (1) is located on the driver's door.

If no operation of the rear windows by switch (for instance by children) is desired, slide override switch (1) to the right; the  symbol becomes visible.

Operation of the rear door windows with the switches located in the driver's door is still possible.

**Synchronizing power windows**

If the power supply was interrupted, (battery disconnected or low), the windows cannot be opened or closed by the express feature.

To resynchronize the express feature, pull switch until the window is completely closed and hold for approximately 1 second. Repeat procedure for each window.

The automatic full opening and closing procedure of the windows should now be restored.

## Sliding/pop-up roof



- 1 to slide roof open
- 2 to slide roof closed
- 3 to raise roof at rear
- 4 to lower roof at rear

Turn the electronic key in starter switch to position 1 or 2.

To open, close, raise or lower the sliding/pop-up roof: Move the switch to resistance point in the required direction.

Release the switch when the roof has reached the required position.

### Warning!

**When closing the sliding/pop-up roof, be sure that there is no danger of anyone being harmed by the closing procedure.**

**When leaving the vehicle, always remove the electronic key from starter switch, and lock your vehicle. Do not leave children unattended in the vehicle, or with access to an unlocked vehicle. Unsupervised use of vehicle equipment can cause serious personal injury.**



## Interior equipment

188

**Opening or closing the sliding/pop-up roof automatically**

Move the switch past resistance point in the direction required and release.

The sliding/pop-up roof opens or closes completely.

Stopping the sliding/pop-up roof:

Move the switch in any direction.

If the movement of the sliding/pop-up roof is blocked during the closing procedure, the roof will stop and reopen slightly.

**Warning!**

**When closing the sliding/pop-up roof, be sure that there is no danger of anyone being harmed by the closing procedure.**

**When leaving the vehicle, always remove the electronic key from starter switch, and lock your vehicle. Do not leave children unattended in the vehicle, or with access to an unlocked vehicle. Unsupervised use of vehicle equipment can cause serious personal injury.**

With the roof closed or tilted open, a screen can be slid into the roof opening to guard against sun rays. When sliding the roof open, the screen will also retract.

Notes:

The sliding/pop-up roof can also be opened and closed using the summer opening/convenience feature, see page 29.

To avoid damaging the seals, do not transport any objects with sharp edges which can stick out of the sliding/pop-up roof.

The sliding/pop-up roof can be opened or closed manually should an electrical malfunction occur, see page 335.

**Synchronizing the sliding/pop-up roof**

The sliding/pop-up roof must be resynchronized if the power supply has been interrupted (battery disconnected or low), the sliding/pop-up roof has been closed manually or the sliding/pop-up roof does not open smoothly or malfunctions.

- Press the switch in the “raise” (3) direction, wait until the sliding/pop-up roof is fully raised at rear and hold the switch for approximately 1 second.

## Interior lighting



### 1 Rear interior lights

Press the button to switch the rear passenger compartment lights on/off.

### 2 Right front reading lamp

Press the button to switch the reading lamp on or off. The right reading lamp will be switched on or off.

### 3 To switch off automatic function: Press the rocker switch.

The interior lighting remains switched off, even when unlocking the vehicle or opening a door or the electronic key is removed from the starter switch.

### 4 To select automatic function: Press the rocker switch to the center position.

Interior lamps are switched on, and off (soft fade) delayed, when unlocking or locking the vehicle, or when opening or closing a door. However, there will be no delay when the electronic key is in starter switch position 2.

### 5 Interior lamps, front: Press rocker switch in to switch front interior lamps on. The interior lighting stays on while the rocker switch is pressed in.

Switching off the front interior lighting:  
Press rocker switch to position (3) or (4).

### 6 Left front reading lamp: Press the button to switch the reading lamp on or off. The left reading lamp will be switched on or off.

## Interior equipment

190

## Notes:

The time delay for the interior light to switch off after the electronic key is removed from the starter switch can be adjusted in the “Individual settings” – “LIGHTING”. See page 117.

To prevent the vehicle battery from being discharged with doors open, all interior lamps switch off after approximately 5 minutes.

An interior lamp switched on manually does not go out automatically. Before leaving the vehicle, make sure that all interior lamps are switched off.

**Door entry lamps**

The appropriate entry lamp switches on if a door is opened in darkness and if the interior lighting is switched to automatic function.

The entry lamp switches off automatically when the door is closed.

## Rear window sunshade (optional)

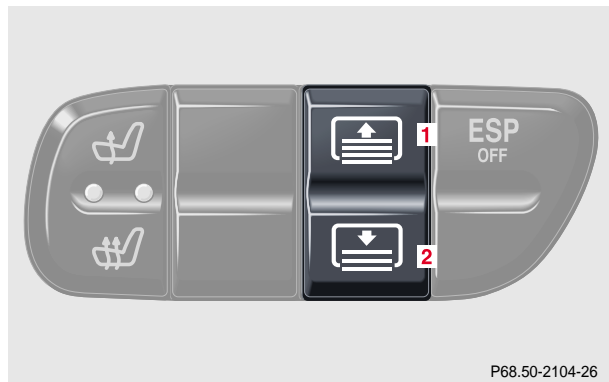

The switch is located in the center console.

Turn the electronic key in starter switch to position 1 or 2.

Press the switch briefly:

- 1** to raise
- 2** to lower

Always raise the sunshade fully for its support against the window frame.

### Warning!

**When operating the rear window sunshade, be sure that there is no danger of anyone being harmed by the raising or lowering procedure.**

**The raising or lowering procedure can be immediately halted by briefly pressing the upper or lower half of the switch.**

**Briefly press upper or lower half of the switch again to raise or lower the rear window sunshade completely.**

**When leaving the vehicle, always remove the electronic key from starter switch, and lock your vehicle. Do not leave children unattended in the vehicle, or with access to an unlocked vehicle. Unsupervised use of vehicle equipment can cause serious personal injury.**

## Interior equipment

192

## Sun visors

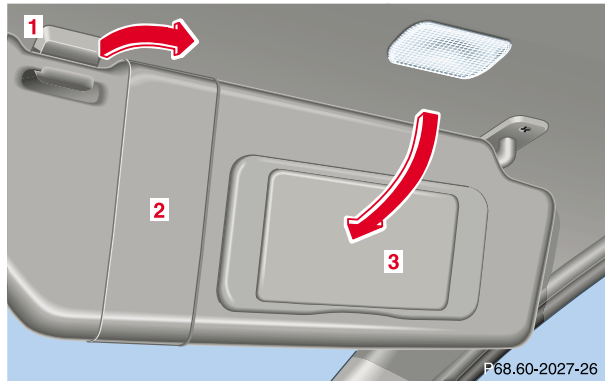

Swing sun visors (2) down (arrow 3) to protect against sun glare.

If sunlight enters through a side window, disengage sun visor (2) from the inner mounting (1) and pivot to the side.

## Vanity mirrors

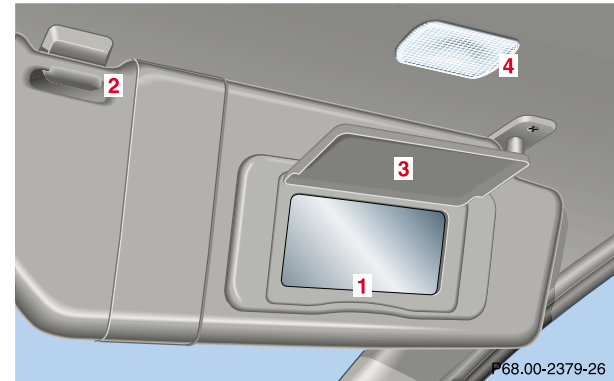

## 1 Illuminated vanity mirror

With the visor engaged in its inner mounting (2), the lamp (4) can be switched on by opening the cover (3).

Fold the cover (3) down to close the vanity mirror.

**Warning!**

**Do not use the vanity mirror while driving.**

## Interior

### Warning!

To help avoid personal injury during a collision or sudden maneuver, exercise care when stowing things. Put luggage or cargo in the trunk if possible. Do not pile luggage or cargo higher than the seat backs. Do not place anything on the shelf below the rear window.

Luggage nets cannot secure hard or heavy objects.

## Storage compartments and armrests

### Warning!

Keep compartment lids closed. This will help to prevent stored objects from being thrown about and injuring vehicle occupants during an accident.

## Interior equipment

194

## Glove box

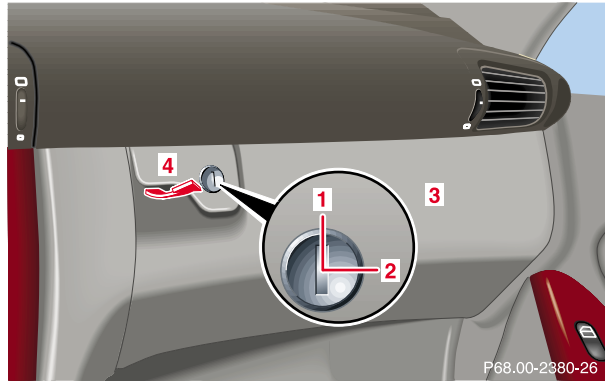

- 1 Unlocked position
- 2 Locked position
- 3 Glove box
- 4 Glove box lid release  
Pull to open

## Notes:

Prior to closing the glove box, close the compartment for glasses first.

The glove box can be locked and unlocked with the mechanical key. See page 23 for instructions on how to remove the mechanical key from the electronic main key (e.g. for valet parking service).

## Storage compartment in front of armrest



**5** Storage compartment in front of armrest

To open:  
Slide cover (5) rearward.

To close:  
Slide cover (5) forward.

Note:

The compartment contains a lighter (see page 201), a coin holder, and a cup holder (see page 197).



## Interior equipment

196

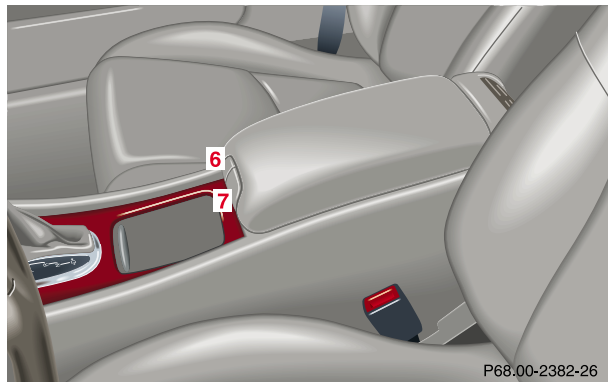
**Storage compartment below the front armrest**

To open compartment in armrest:  
Lift armrest by handle (6).

To open compartment under armrest:  
Lift armrest by handle (7).

To close:  
Lower armrest until it engages in lock.

To change inclination of armrest:  
Pull up on armrest.

To lower armrest:  
Pull handle (7).

Notes:

The storage compartment can be heated or cooled, see page 158.

The compartment can get very warm due to its confined space. When storing heat sensitive objects in the compartment, close the air outlet while heating the passenger compartment.

Do not obstruct the air outlet in the storage compartment.

## Cup holder



### 1 Cup holder in front seat armrest

Open the storage compartment in front of the armrest, see page 195.

Close the storage compartment in front of the armrest, see page 195.

### Warning!

Keep the cup holder closed while traveling. Place only containers that fit into the cup holder to prevent spills. Do not fill containers to a height where the contents could spill during vehicle maneuvers, especially hot liquids.

## Interior equipment

198

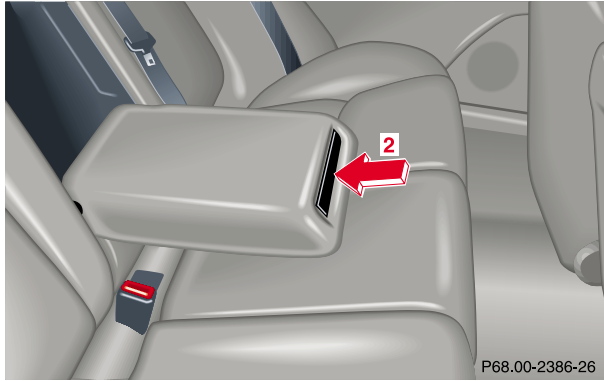

2 Cup holder in rear seat armrest

To open:  
Push front of sliding compartment – the cup holder slides out.

To close:  
Push the sliding compartment back until it engages.

**Warning!**

**Keep the cup holder closed while traveling. Place only containers that fit into the cup holder to prevent spills. Do not fill containers to a height where the contents could spill during vehicle maneuvers, especially hot liquids.**

## Ashtrays

### Center console

To open:

Briefly touch the mark on the cover, the ashtray opens automatically.

To remove ashtray insert from center console:

#### Warning!

**Remove front ashtray only with vehicle standing still. With the gear selector lever in position “N”, turn off the engine and set the parking brake. Otherwise the vehicle might move as a result of unintended contact with the gear selector lever.**

Prior to removing the ashtray insert, move the gear selector lever to position “N”.

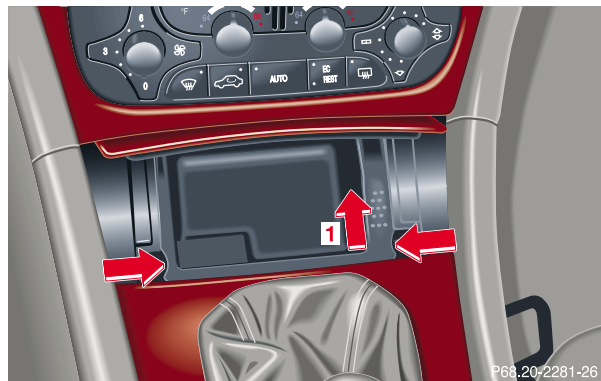

Slide ashtray insert in direction of arrow (1) until the insert disengages. Grip ashtray insert at indents (left and right arrows) and remove from ashtray frame.

To replace insert:

Install insert into ashtray frame and push down to engage into place.

## Interior equipment

## Rear seats

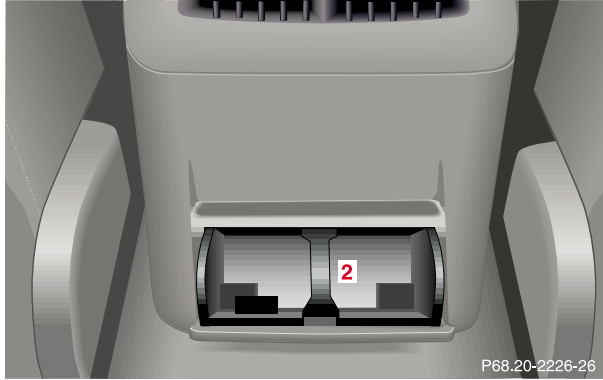

## 200

To open ashtray:

Pull at top of cover.

To remove insert:

Press latch (2) and remove insert.

To replace insert:

Install insert and close the ashtray.

## Lighter



### 1 Center console lighter

The lighter is located in the center console compartment in front of the armrest, see page 195.

Turn the electronic key in starter switch to position 1 or 2.

Push in lighter in (1); it will pop out automatically when hot.

### Warning!

**Never touch the heating element or sides of the lighter, they are extremely hot, hold at knob only.**

**When leaving the vehicle always remove the electronic key from the starter switch. Do not leave children unattended in the vehicle, or with access to an unlocked vehicle. Unsupervised use of vehicle equipment may cause serious personal injury.**

Note:

The lighter can be operated with electronic key in starter switch position 1 or 2.

The lighter socket can be used to accommodate electrical accessories up to a maximum 85 W.

## Interior equipment

202

**Parcel net in front passenger footwell**

A small convenience parcel net is located in the front passenger footwell. It is for small and light items, such as road maps, mail, etc.

**Warning!**

**Do not place heavy or fragile objects, or objects having sharp edges, in the parcel net.**

**In an accident, during hard braking or sudden maneuvers, they could be thrown around inside the vehicle, and cause injury to vehicle occupants.**

**Ski sack (optional)****Unfolding and loading**

1. Fold armrest down (arrow).
2. Swing cover (1) down.

P91.12-2150-26



3. Open hook and loop strap (2) and pull ski sack into passenger compartment and unfold.

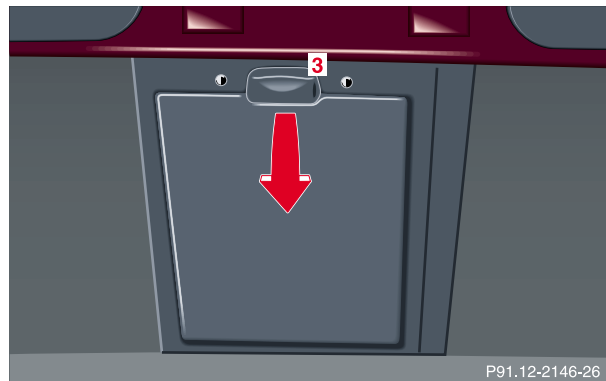

4. Open flap in trunk by pulling handle (3).



## Interior equipment

204

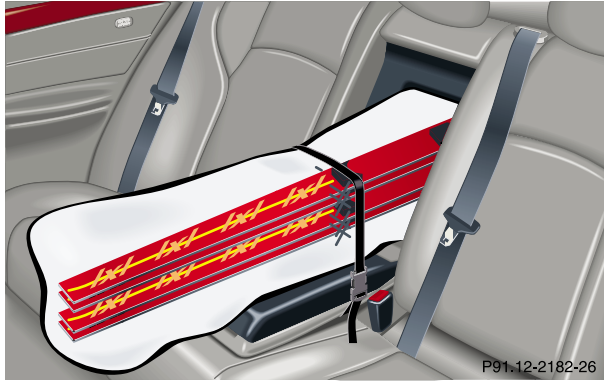

5. From trunk, slide skis into ski sacks

**Warning!**

The ski sack is designed for up to four pairs of skis.  
Do not load the ski sack with other objects

Always fasten the ski sack securely. In an accident,  
an unfastened ski sack can cause injury to vehicle  
occupants.

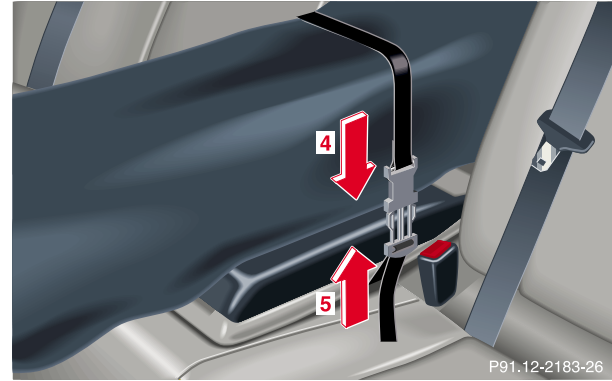

6. Wrap strap around ski sack and armrest.

7. Close clasp (arrows 4 and 5) and pull strap tight to  
immobilize skis.

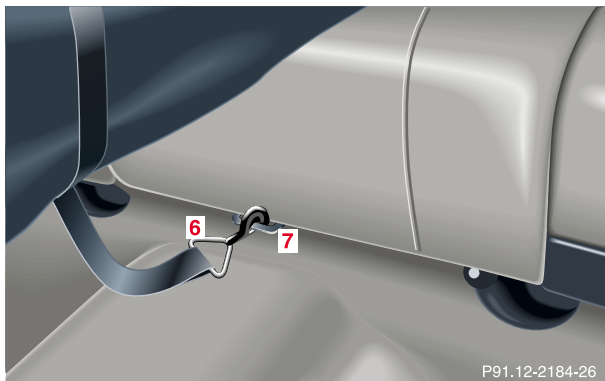

8. Connect snap hook (6) of front strap to eye (7) located on center tunnel in front of rear seat bench.

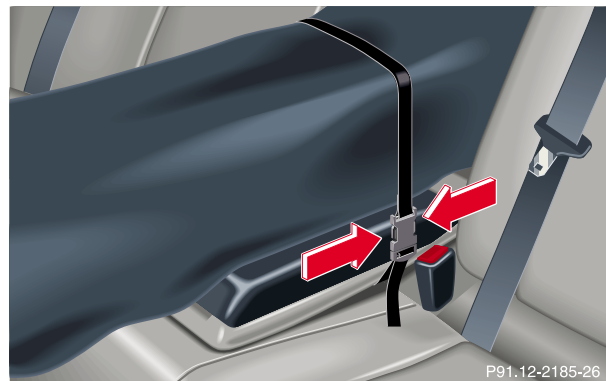

### Unloading and folding

1. Loosen strap, open clasp by pressing tabs (arrows) together, and unload skis.
2. Close flap in trunk.
3. Disconnect snap hook (6) from eye (7).
4. Fold and flatten ski sack lengthwise and place folded ski sack inside recess of backrest.

## Interior equipment

206



5. Close ski sack compartment cover.

**Removal of ski sack**

For removal of the ski sack we recommend that you contact an authorized Mercedes-Benz Center.

**Warning!**

**Never drive vehicle with trunk lid open while the ski sack is removed. Deadly carbon monoxide (CO) gases may enter vehicle interior resulting in unconsciousness and death.**

**Note:**

To prevent unauthorized persons from access to the trunk, always close the pass-through.

## Enlarged cargo area (optional)

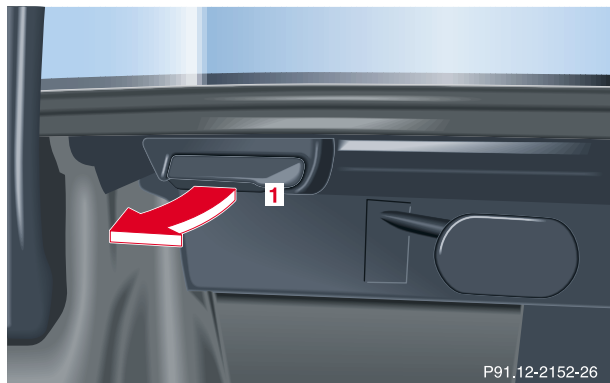

1. Pull handle (1) located in trunk to unlock backrest.

On vehicles with optional split folding rear seat backrest you can fold down the two sections separately to enlarge the cargo area.

## Split folding rear seat bench

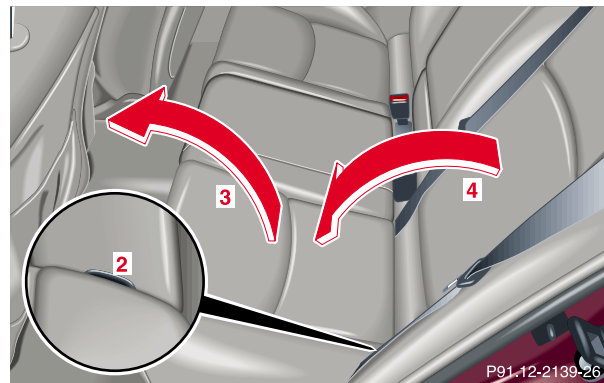

2. Pull handle (2) and fold seat cushion (3) forward.
3. Fully retract and fold down head restraints, see page 52.
4. Fold backrest (4) forward.

## Interior equipment

208

## Setting up rear seat bench

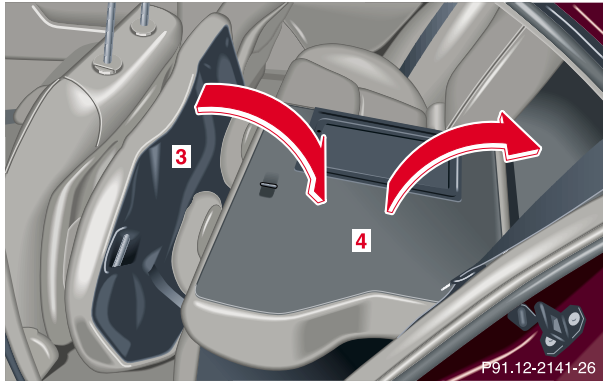

1. Pull backrest (4) up until it locks in its upright position. Check for secure locking by pushing and pulling on the backrest.

The pop-up indicators (5) (left and right backrest section) are visible in unlocked position. With backrest sections in upright and locked position, the indicators (5) are fully lowered.

2. Fold seat cushion (3) back until it locks in place. Check for secure locking by pressing on the seat cushion.

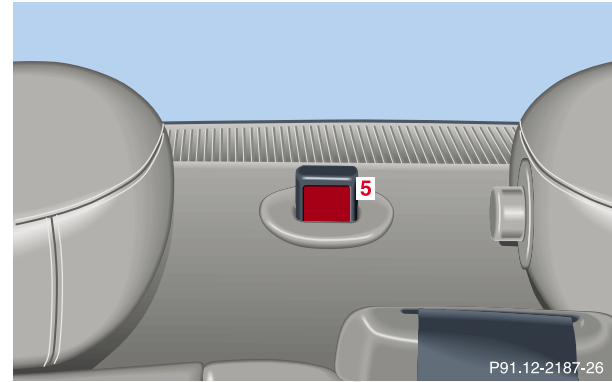
**Warning!**

**Always lock backrest in its upright position when rear seat bench is occupied by passengers, cargo is being carried in the trunk, or the extended cargo area is not in use.**

**Note:**

To prevent unauthorized persons from access to the trunk, always lock backrest in its upright position.

## Loading instructions (Vehicle with enlarged cargo area)

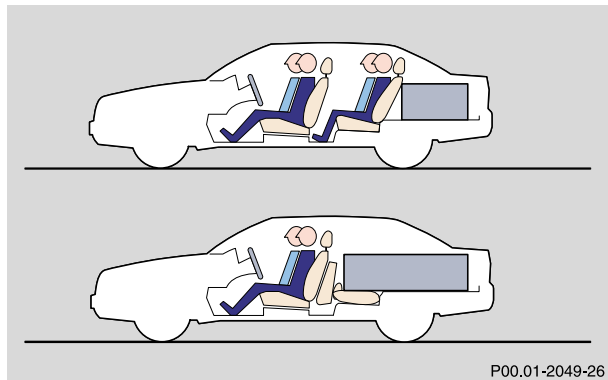

The total load weight including vehicle occupants and luggage/cargo should not exceed the vehicle capacity weight indicated on the certification tag which can be found on the left door pillar.

The handling characteristics of a fully loaded vehicle depend greatly on the load distribution. It is therefore recommended to load the vehicle according to the illustrations shown, with the heaviest items being placed towards the front of the vehicle.

Always place items being carried against front or rear seat backrests, and fasten them as securely as possible.

The heaviest portion of the cargo should always be kept as low as possible since it influences the handling characteristics of the vehicle.

Note:

The trunk is the preferred place to carry objects.

The enlarged cargo area should only be used for items which do not fit in the trunk alone.

**Warning!**

**In an accident, during hard braking or sudden maneuvers, loose items will be thrown around inside the vehicle and can cause injury to vehicle occupants unless the items are securely fastened in the vehicle.**

**To help avoid personal injury during a collision or sudden maneuver, exercise care when stowing things. Put luggage or cargo in the trunk if possible. Do not pile luggage or cargo higher than the seat backs. Do not place anything on the shelf below the rear window.**

**Never drive vehicle with trunk lid open while seat backrest sections not locked in their upright position. Deadly carbon monoxide (CO) gases may enter vehicle interior resulting in unconsciousness and death.**

**Cellular telephone**

The vehicle is prepared for the installation of a cellular telephone. For further information and installation contact your authorized Mercedes-Benz Center.

**Warning!**

**Some jurisdictions prohibit the driver from using a cellular telephone while driving a vehicle. Whether or not prohibited by law, for safety reasons, the driver should not use the cellular telephone while the vehicle is in motion.**

**Stop the vehicle in a safe location before answering or placing a call.**

## Telephone, general

### Warning!

A driver's attention to the road must always be his/her primary focus when driving. For your safety and the safety of others, we recommend that you pull over to a safe location and stop before placing or taking a telephone call. If you choose to use the telephone while driving, please use the hands-free device and only use the telephone when road and traffic conditions permit.

Some jurisdictions prohibit the driver from using a cellular telephone while driving a vehicle.

Bear in mind that at a speed of just 30 mph (approximately 50 km/h), your vehicle is covering a distance of approximately 50 feet (approximately 14 m) every second.

Never operate radio transmitters equipped with a built-in or attached antenna (i.e. without being connected to an external antenna) from inside the vehicle while the engine is running. Doing so could lead to a malfunction of the vehicle's electronic system, possibly resulting in an accident and personal injury.

See separate instruction manual for instructions on how to operate the telephone.



## Garage door opener

212

## Garage door opener

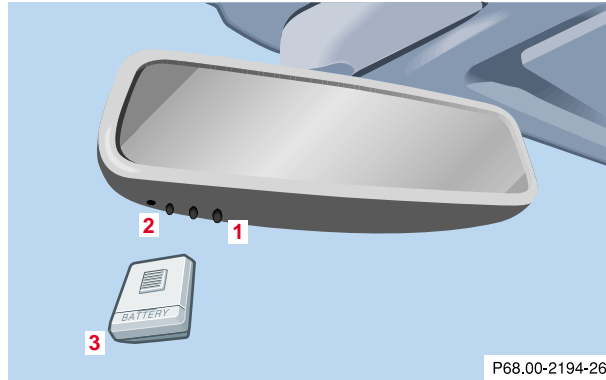

- 1 Signal transmitter keys
- 2 Indicator lamp
- 3 Portable remote control transmitter

The built-in remote control is capable of operating up to three separately controlled objects.

**Warning!**

**When programming a garage door opener, the door moves up or down.**

**When programming or operating the remote control make sure there is no possibility of anyone being harmed by the moving door.**

Note:

Certain types of garage door openers are incompatible with the integrated opener. If you should experience difficulties with programming the transmitter, contact your authorized Mercedes-Benz Center, or call Mercedes-Benz Client Assistance Center (in the USA only) at 1-800-FOR-MERCEDES, or Customer Service (in Canada) at 1-800-387-0100.

For operation in the USA only: This device complies with Part 15 of the FCC Rules. Operation is subject to the following two conditions:

- (1) This device may not cause harmful interference, and
- (2) this device must accept any interference received, including interference that may cause undesired operation.

Any unauthorized modification to this device could void the user's authority to operate the equipment.

### **Programming or reprogramming the integrated remote control:**

1. Turn electronic key in starter switch to position 1 or 2.
2. Hold the end of the hand-held transmitter of the device you wish to train approximately 2 to 5 inches (5 cm to 12 cm) away from the surface of the integrated remote control located on the inside rear view mirror, keeping the indicator lamp in view.

## Garage door opener

214

- Using both hands, simultaneously push the hand-held transmitter button and the desired integrated remote control button. Do not release the buttons until completing step 4.
- The indicator lamp on the integrated remote control will flash, first slowly and then rapidly. When the indicator lamp flashes rapidly, both buttons may be released (the rapid flashing lamp indicates successful programming of the new frequency signal). To program the remaining two buttons, follow steps 1 through 4.

## Note:

If, after repeated attempts, you do not successfully program the integrated remote control device to learn the signal of the hand-held transmitter, the garage door opener could be equipped with the “rolling code feature”.

**Rolling code programming:**

To train a garage door opener (or other rolling code devices) with the rolling code feature, follow these instructions after completing the “Programming” portion of this text. (A second person may make the following training procedures quicker and easier.)

- Locate training button on the garage door opener motor head unit. Exact location and color of the button may vary by garage door opener brand. If there is difficulty locating the transmitting button, reference to garage door opener operator’s manual.
- Press “training” button on the garage door opener motor head unit (which activated the “training light”).

## Note:

Following step 2, there are 30 seconds to initiate step 3.

3. Firmly press and release the programmed integrated remote control transmit button. Press and release same button a second time to complete the training process. (Some garage door openers may required you to do this procedure a third time to complete the training.)
4. Confirm the garage door operation by pressing the programmed button on the integrated remote control transmitter.

**Canadian programming:**

During programming, your hand-held transmitter may automatically stop transmitting. Continue to press and hold the integrated remote control transmitter button (note steps 2 through 4 in the “Programming” portion) while you press and re-press (“cycle”) your hand-held transmitter every two seconds until the frequency signal has been learned. The indicator lamp will flash slowly and then rapidly after several seconds upon successful training.

## Garage door opener

216

**Operation of remote control:**

1. Turn electronic key in starter switch to position 1 or 2.
2. Select and press the appropriate button to activate the remote controlled device. The integrated remote control transmitter continues to send the signal as long as the button is pressed – up to 20 seconds.

**Erasing the remote control memory:**

1. Turn electronic key in starter switch to position 1 or 2.
2. Simultaneously holding down the left and right side buttons for approximately 20 seconds, or until the control lamp blink rapidly, will erase the codes of all three channels.

## Driving

Control and operation of radio transmitters .....	218
The first 1 000 miles (1 500 km) .....	219
Maintenance .....	219
Tele Aid .....	220
Catalytic converter .....	228
Emission control .....	229
Starter switch .....	230
Starting and turning off the engine .....	232
Manual transmission .....	233

Automatic transmission .....	234	Deep water .....	252
Parking brake .....	243	Passenger compartment .....	253
Driving instructions .....	244	Traveling abroad .....	253
Drive sensibly – Save Fuel .....	244	Cruise control .....	254
Drinking and driving .....	244	Brake assist system (BAS) .....	257
Pedals .....	244	Antilock brake system (ABS) .....	258
Power assistance .....	245	Electronic stability program (ESP) .....	260
Brakes .....	245	What you should know at the gas station .....	264
Driving off .....	246	Check regularly and before a long trip .....	266
Parking .....	246		
Tires .....	247		
Snow chains .....	250		
Winter driving instructions .....	250		

**Control and operation of radio transmitters**

## COMAND, radio, telephone and two-way radio

**Warning!**

Please do not forget that your primary responsibility is to drive the vehicle. Only operate the COMAND (Cockpit Management and Data System), radio, telephone<sup>1</sup> or two-way radio<sup>1</sup> if road and traffic conditions permit.

Bear in mind that at a speed of just 30 mph (approximately 50 km/h), your vehicle is covering a distance of approximately 50 feet (approximately 14 m) every second.

## Telephones and two-way radio

**Warning!**

Never operate radio transmitters equipped with a built-in or attached antenna (i.e. without being connected to an external antenna) from inside the vehicle while the engine is running. Doing so could lead to a malfunction of the vehicle's electronic system, possibly resulting in an accident and personal injury.

Radio transmitters, such as a portable telephone or a citizens band unit should only be used inside the vehicle if they are connected to an antenna that is installed on the outside of the vehicle.

Refer to the radio transmitter operation instructions regarding use of an external antenna.

1 Observe all legal requirements.

### The first 1 000 miles (1 500 km)

The more cautiously you treat your vehicle during the break-in period, the more satisfied you will be with its performance later on. Therefore, drive your vehicle during the first 1 000 miles (1 500 km) at moderate vehicle and engine speeds.

During this period, avoid heavy loads (full throttle driving) and excessive engine speeds.

Avoid accelerating by kickdown. It is not recommended to brake the vehicle by manually shifting to a lower gear. We recommend that you select positions “3”, “2” or “1” only at moderate speeds (for hill driving).

After 1 000 miles (1 500 km) speeds may be gradually increased to the permissible maximum.

### Maintenance

Approximately 30 days or 2000 miles (2000 km) prior to the next recommended service, the remaining distance or days are displayed in the multifunction indicator. See Flexible service system (FSS) on page 125.

We strongly recommend that you have your vehicle serviced by your authorized Mercedes-Benz Center, in accordance with the Service Booklet at the times called for by the FSS.

Failure to have the vehicle maintained in accordance with the Service Booklet at the designated times/mileage may result in vehicle damage not covered by the Mercedes-Benz Limited Warranty.



## Tele Aid



### Important!

The initial activation of the Tele Aid system may only be performed by completing the subscriber agreement and placing an acquaintance call using the “SOS” button. Failure to complete either of these steps will result in a system that is not activated.



If you have any questions regarding activation, please call the Response Center at 1-800-756-9018 (in the USA) or 1-888-923-8367 (in Canada).

### (Telematic Alarm Identification on Demand)

The Tele Aid system consists of three types of response; automatic and manual emergency, roadside assistance and information.

The Tele Aid system is always operational, providing that the vehicle’s battery is charged and properly connected. To activate, press the “SOS” button, the Roadside Assistance button  or the Information button , depending on the type of response required.

### System self-check

Initially, after turning the electronic key in starter switch to position 2, malfunctions are detected and indicated (the indicator lamps in the “SOS” button, the Roadside Assistance button  and the Information button  stay on longer than 5 seconds or do not come on).

If a malfunction is indicated as outlined above, have the system checked at the nearest Mercedes-Benz Center as soon as possible.

### Important!

Always make sure that the indicator lamp in the “SOS” button remains illuminated for approximately 5 seconds during the system self-check after turning electronic key in starter switch to position 2.

### Emergency calls

An emergency call is initiated automatically following an accident in which the Emergency Tensioning Retractors (ETR’s) or airbags deploy. An emergency call can also be initiated manually by opening the cover next to the inside rear view mirror labeled “SOS”, then

pressing the button (for longer than 2 seconds) located under the cover. See below for instructions on initiating an emergency call manually.

Once the emergency call is in progress, the indicator lamp in the “SOS” button will begin to flash. The message “EMERGENCY CALL – ESTABLISHING CALL” appears in the multifunction display. When the connection is established, the message “EMERGENCY CALL – CALL CONNECTED” appears in the multifunction display. All information relevant to the emergency, such as the location of the vehicle (determined by the GPS satellite location system), vehicle model, identification number and color are generated.

A voice connection between the Response Center and the occupants of the vehicle will be established automatically soon after the emergency call has been initiated. The Response Center will attempt to determine more precisely the nature of the accident provided they can speak to an occupant of the vehicle.

The Tele Aid system is available if:

- it has been activated and is operational. Activation requires a subscription for monitoring services and cellular air time,
- the relevant cellular phone network and GPS signals are available.

Note:

Location of the vehicle on a map is possible if the vehicle is able to receive signals from the GPS satellite network.

#### **Warning!**

**If the indicator lamp in the “SOS” button is illuminated continuously and there was no voice connection to the Response Center established, then the Tele Aid system could not initiate an emergency call (e.g. the relevant cellular phone network is not available). The message “EMERGENCY CALL – CALL FAILED” appears in the multifunction display.**

**Should this occur, assistance must be summoned by other means.**

### Initiating an emergency call



Manually:  
Briefly press on cover (1) – the cover will open.



Press the emergency call switch (2) briefly (for longer than 2 seconds). The indicator lamp in the emergency call switch (2) will flash until the emergency call is concluded. Wait for a voice connection to the Response Center.

Close the cover (1) after the emergency call is concluded.

## Warning!

**If you feel at any way in jeopardy when in the vehicle (e.g. smoke or fire in the vehicle, vehicle in a dangerous road location), please do not wait for voice contact after you have pressed the emergency button. Carefully leave the vehicle and move to a safe location. The Response Center will automatically contact local emergency officials with the vehicle's approximate location if they receive an "SOS" signal and cannot make voice contact with the vehicle occupants.**

## Roadside Assistance button



Located below the center armrest cover is the Roadside Assistance button . Pressing and holding the button (for longer than 2 seconds) will initiate a call to a Mercedes-Benz Roadside Assistance dispatcher. The button will flash while the call is in progress. The Tele Aid system will transmit data generating the vehicle identification number, model, color and location (subject to availability of cellular and GPS signals).

A voice connection between the Roadside Assistance dispatcher and the occupants of the vehicle will be established. The nature of the need for assistance can then be described. Sign and Drive services (jump start, a few gallons of fuel or the replacement of a flat tire with the vehicle spare tire) are available.

If the vehicle requires more than Sign and Drive services, the Mercedes-Benz Roadside assistance dispatcher will either dispatch a qualified Mercedes-Benz technician or arrange to tow your vehicle to the nearest Mercedes-Benz Center.

For other than Sign and Drive services, labor and/or towing charges may apply. Refer to the Roadside Assistance manual for more information.

## Notes:

The indicator lamp in the Roadside Assistance button  remains illuminated in red for approximately 5 seconds during the system self-check after turning electronic key in starter switch to position 2 (together with the "SOS" button and the Information button .

See system self-check on page 220 when the indicator lamp does not light up in red or stays on longer than approximately 5 seconds.

**Information button** 



Located below the center armrest cover is the Information button . Pressing and holding the button (for longer than 2 seconds) will initiate a call to the Client Assistance Center. The button will flash while the call is in progress. The Tele Aid system will transmit data generating the vehicle identification number, model, color and location (subject to availability of cellular and GPS signals).

A voice connection between the Client Assistance Center representative and the occupants of the vehicle will be established. Information regarding the operation of your vehicle, the nearest Mercedes-Benz Center or Mercedes-Benz USA products and services is available to you.

If you have chosen the Route Guidance Service (an optional service available at additional cost in the USA only), your communication will be transferred to our Response Center, who will provide the appropriate information.

For more details concerning this optional service, please contact the Response Center at 1-800-756-9018.

## Notes:

The indicator lamp in the Information button  remains illuminated in red for approximately 5 seconds during the system self-check after turning electronic key in starter switch to position 2 (together with the “SOS” button and the Roadside Assistance button ).

See system self-check on page 220 when the indicator lamp does not light up in red or stays on longer than approximately 5 seconds.

**Important!**

If the indicator lamps do not illuminate or remain illuminated (in red) at any time, the Tele Aid system has detected a fault or the service is not currently active, and may not initiate a call. Visit your Mercedes-Benz Center and have the system checked or contact the Response Center at 1-800-756-9018 (in the USA) or 1-888-923-8367 (in Canada) as soon as possible.

## Upgrade Signals

Tele Aid system processes calls using the following priority.

- Automatic emergency – First priority
- Manual emergency – Second priority
- Roadside assistance – Third priority
- Information – Fourth priority

Should a higher priority call be initiated while you are connected, an upgrade (alternating) tone will be heard, and the appropriate indicator lamp will flash. If certain information such as vehicle identification number or client information is not available, the operator may need to retransmit. During this time you will hear a chirp and voice contact will be interrupted. Voice contact will resume once the retransmission is complete. Once a call is concluded, a chirp will be heard, the appropriate indicator lamp will stop flashing and a tone will be heard indicating that the system has reset.

## Important!

If the indicator lamp continues to flash or the system does not reset, contact the Response Center at 1-800-756-9018 (in the USA) or 1-888-923-8367 (in Canada), or Mercedes-Benz Client Assistance at 1-800-FOR-MERCEdes (1-800-367-6372) in the USA or Customer Service at 1-800-387-0100 in Canada.

## Notes:

The indicator lamp in the respective button flashes until the call is concluded and this can only be completed by a Response Center or Client Assistance Center representative.

**Remote door unlock**

In the case you have your vehicle locked unintentionally (e.g. key inside vehicle), and the reserve key is not handy, contact the Mercedes-Benz Response Center at 1-800-756-9018 (in the USA) or 1-888-923-8367 (in Canada). You will be asked to provide your password which you provided when you completed the subscriber agreement.

Then return to your vehicle and pull outside trunk handle for a minimum of 20 seconds.

The Response Center will then unlock your vehicle with the remote door unlocking feature.

**Note:**

The remote door unlock feature is available if the relevant cellular phone network and GPS signals are available.

**Vehicle location/stolen vehicle tracking services**

Should you wish to locate your vehicle, contact the Mercedes-Benz Response Center at 1-800-756-9018 (in the USA) or 1-888-923-8367 (in Canada). You will be asked to provide your password which you provided when you completed the subscriber agreement.

In the event your vehicle was stolen, report the incident to the police who will issue a numbered incident report. Pass this number on to the Mercedes-Benz Response Center.

The Response Center will then attempt to covertly contact the vehicle's Tele Aid system. The electronic key in the starter switch must be in position 1 or 2 and the cellular and GPS signals must be available. The Response Center will contact you at the phone number(s) provided in the agreement once the vehicle is located. The Response Center will attempt to contact the vehicle until located, up to a maximum of 14 days or until the vehicle location incident report is cancelled by you.

**Starguide** (except Canada)  
(only vehicles with optional COMAND system)

If you have chosen Starguide Service, you can request several individual informations, for example the latest news or stock market reports, information about weather and travel or get your e-mail on the COMAND.

For notes on operation see separate COMAND operator's manual.

For more details concerning this optional service, please contact the Response Center at 1-800-756-9018 (in the USA).

### **Important!**

Tele Aid utilizes the cellular network for communication and the GPS (Global Positioning System) satellites for vehicle location. If either of these signals are unavailable, the Tele Aid system may not function and if this occurs, assistance must be summoned by other means.

### **Warning!**

**If the indicator lamp in the “SOS” button does not illuminate during or remains illuminated after the system self-check, have the system checked at the nearest Mercedes-Benz Center as soon as possible.**



### Catalytic converter

Your Mercedes-Benz is equipped with monolithic type catalytic converters, an important element in conjunction with the oxygen sensors to achieve substantial control of the pollutants in the exhaust emissions. Keep your vehicle in proper operating condition by following our recommended maintenance instructions as outlined in your Service Booklet.

#### Caution!

To prevent damage to the catalytic converters, use only premium unleaded gasoline in this vehicle.

Any noticeable irregularities in engine operation should be repaired promptly. Otherwise, excessive unburned fuel may reach the catalytic converter causing it to overheat, which could start a fire.

#### Warning!

**As with any vehicle, do not idle, park or operate this vehicle in areas where combustible materials such as grass, hay or leaves can come into contact with the hot exhaust system, as these materials could be ignited and cause a vehicle fire.**

## Emission control

Certain systems of the engine serve to keep the toxic components of the exhaust gases within permissible limits required by law.

These systems, of course, will function properly only when maintained strictly according to factory specifications. Any adjustments on the engine should, therefore, be carried out only by qualified Mercedes-Benz Center authorized technicians. Engine adjustments should not be altered in any way. Moreover, the specified service jobs must be carried out regularly according to Mercedes-Benz servicing requirements. For details refer to the Service Booklet.

### Warning!

**Inhalation of exhaust gas is hazardous to your health. All exhaust gas contains carbon monoxide, and inhaling it can cause unconsciousness and lead to death.**

**Do not run the engine in confined areas (such as a garage) which are not properly ventilated. If you think that exhaust gas fumes are entering the vehicle while driving, have the cause determined and corrected immediately. If you must drive under these conditions, drive only with at least one window fully open.**

## Starter switch

230

## Starter switch

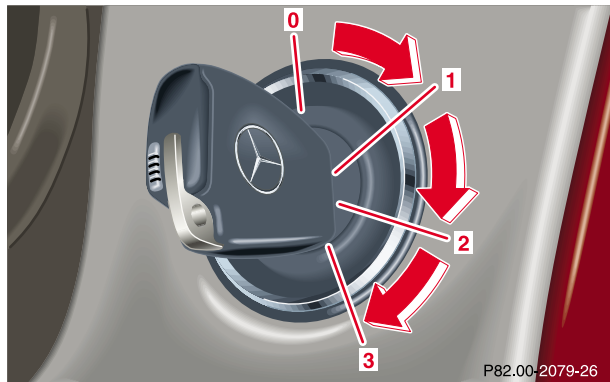

- 0** The electronic key can be withdrawn in this position only. The steering is locked when the electronic key is removed from the starter switch. If necessary, move steering wheel slightly to allow the locking mechanism to engage.

In vehicles with automatic transmission, the electronic key can be removed only with the selector lever in position “P”. After removing the electronic

key or with the electronic key in starter switch position 0, the selector lever is locked in position “P”.

- 1** Gear selector lever is unlocked.

Most electrical consumers can be operated. For detailed information see respective subjects.

- 2** Driving position.

- 3** Starting position.

See page 232 for instructions on starting and stopping the engine.

**Warning!**

**When leaving the vehicle always remove the electronic key from the starter switch, and lock the vehicle. Do not leave children unattended in the vehicle, or with access to an unlocked vehicle. Unsupervised use of vehicle equipment may cause serious personal injury.**

### Important!

If the electronic key is left in the starter switch position 0 for an extended period of time, it can no longer be turned in the lock. In this case, remove the electronic key from the starter switch and reinsert it.

### Caution!

To prevent accelerated battery discharge and a possible dead battery, always remove the electronic key from the starter switch. **Do not** leave the electronic key in the starter switch position 0.

### Notes:

A warning sound is emitted when the driver's door is opened with the electronic key in starter switch position 1 or 0.

With the engine at idle speed, the charging rate of the alternator (output) is limited.

It is therefore recommended that you turn off unnecessary electrical consumers while driving in stop-and-go traffic. This precaution helps to avoid draining of the battery.

Unnecessary strain on the battery and charging system may be minimized by turning off the following power consumers, for example:

Heated seats, rear window defroster. In addition, the automatic climate air volume control should be set to the lowest position.

## Starting and turning off the engine

232

### Starting and turning off the engine

#### Before starting

Ensure that parking brake is engaged and that selector lever is in position “P” or “N” (gearshift lever in neutral). Turn electronic key in starter switch to position 2.

#### Starting

Vehicles with automatic transmission:

Do not depress accelerator. Briefly turn electronic key in starter switch clockwise to the stop and release. The starter will engage until the engine is running.

If engine will not run, and the starting procedure stops, turn electronic key completely to the left and repeat starting the engine.

After several unsuccessful attempts, have the system checked at the nearest authorized Mercedes-Benz Center.

Vehicles with manual transmission:

Do not depress accelerator. Fully depress clutch pedal, otherwise the engine cannot be started due to the integrated safety interlock.

Turn electronic key in starter switch clockwise to the stop. Release only when the engine is firing regularly.

#### Important!

Due to the installed starter non-repeat feature, the electronic key must be turned completely to the left before attempting to start the engine again.

In areas where temperatures frequently drop below -4°F (-20°C) we recommend that an engine block heater be installed. Your authorized Mercedes-Benz Center will advise you on this subject, see page 251.

#### Turning off

Turn the electronic key in the starter switch to position 0 to stop the engine.

Vehicles with automatic transmission:

The electronic key can only be removed with the selector lever in position “P”.

## Manual transmission

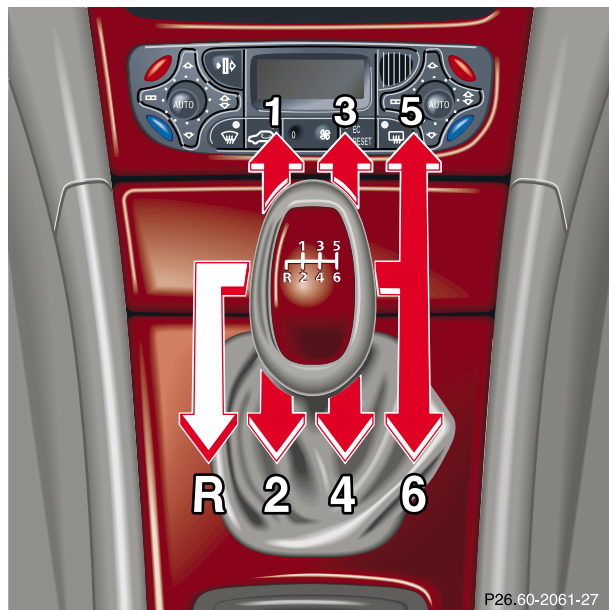

See illustration for gearshift lever positions corresponding to the individual gears.

Stop the vehicle completely before shifting into reverse; to shift into reverse, pull the gearshift lever up.

Do not exceed the maximum engine speed in the individual gears. Refer to tachometer (see page 91) for engine speeds.

### Important!

When vehicle is parked, always be sure to engage first or reverse gear and firmly set parking brake.

When parked on an incline, also turn front wheel towards the road curb.

Downshifting gears leading to overrevving the engine can result in transmission damage that is not covered by the Mercedes-Benz Limited Warranty.

Do not exceed engine speed limits, see page 91.

### Warning!

**On slippery road surfaces as well as high engine speeds, never downshift in order to obtain braking action. This could result in drive wheel slip and reduced vehicle control. Your vehicle's ABS will not prevent this type of loss of control.**

## Automatic transmission

234

**Automatic transmission**

The automatic transmission selects individual gears automatically, dependent upon

- Selector lever position
- Program mode selector
- Accelerator position
- Vehicle speed

The gear shifting process is continuously adapted, dependent on the driving style, the driving situation and the road characteristics.

**Important!**

When parking the vehicle or before working on the vehicle with the engine running, firmly depress the parking brake pedal and shift the selector lever into “P”.

## Driving

The selector lever is automatically locked while in position “P”. To move the selector lever out of position “P”, the service brake pedal must be firmly depressed before the shift lock will release.

Shift selector lever to the desired position only when the engine is idling normally and the service brake is applied. Do not release the brake until ready to drive. The vehicle may otherwise start creeping when the selector lever is in drive or reverse position.

### Warning!

**It is dangerous to shift the selector lever out of “P” or “N” if the engine speed is higher than idle speed. If your foot is not firmly on the brake pedal, the vehicle could accelerate quickly forward on in reverse. You could lose control of the vehicle and hit someone or something. Only shift into gear when the engine is idling normally and when your right foot is firmly on the brake pedal.**

## Important!

After selecting any driving position from “N” or “P”, wait a moment to allow the gear to fully engage before accelerating, especially when the engine is cold.

### Accelerator position

Partial throttle = early upshifting = normal acceleration

Full throttle = later upshifting = rapid acceleration

Kickdown (depressing the accelerator beyond full throttle) = downshifting to a lower gear = maximum acceleration. Once the desired speed is attained, ease up on the accelerator – the transmission shifts up again.



## Automatic transmission

236

**Stopping**

For brief stops, e.g. at traffic lights, leave the transmission in gear and hold vehicle with the service brake.

For longer stops with the engine idling, shift into “N” or “P” and hold the vehicle with the service brake.

When stopping the vehicle on an uphill gradient, do not hold it with the accelerator, use the brake. This avoids unnecessary transmission heat build up.

**Maneuvering**

To maneuver in tight areas, e.g. when pulling into a parking space, control the vehicle speed by gradually releasing the brakes. Accelerate gently and never abruptly step on the accelerator.

To rock a vehicle out of soft ground (mud or snow), alternately shift from forward to reverse, while applying slight partial throttle.

Rocking a vehicle free in this manner may cause the ABS or traction system malfunction indicator lamp to come on. Turn off and restart the engine to clear the malfunction indication.

**Warning!**

**Getting out of your vehicle with the selector lever not fully engaged in position “P” is dangerous. Also, when parked on an incline, position “P” alone may not prevent your vehicle from moving, possibly hitting people or objects.**

**Always set the parking brake in addition to shifting to position “P”, see page 243 for parking brake.**

**When parked on an incline, also turn front wheel against curb.**

## Selector lever position

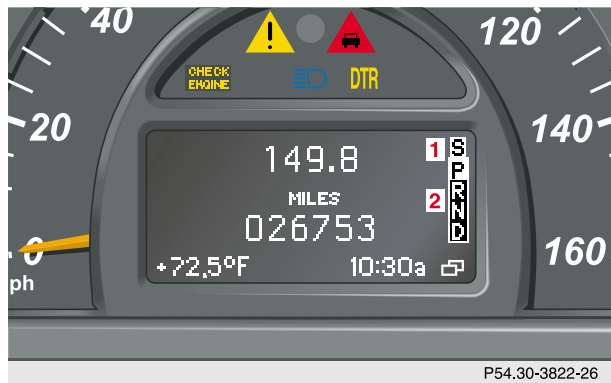

- 1 Program mode indicator, see page 241
- 2 Gear range indicators

The current selector lever position is highlighted in the gear range indicator display (2), as well as shown by a red indicator light next to the gear selector lever. The automatic gear shifting process can be adapted to specific operating conditions using the selector lever.

## **P** Park position

The park position is to be used when parking the vehicle. Engage only with the vehicle stopped. The park position is not intended to serve as a brake when the vehicle is parked. Rather, the driver should always use the parking brake in addition to placing the selector lever in park to secure the vehicle.

Note:

The electronic key can only be removed from the starter switch with the selector lever in position "P". With the electronic key removed, the selector lever is locked in position "P".

## **R** Reverse gear

Shift to reverse gear only with the vehicle stopped.

Dependent on the program mode selector switch position "S" or "W" the maximum speed in the reverse gear is different. However, it is not possible to change the program mode while in reverse.

**N Neutral**

No power is transmitted from the engine to the drive axle. When the brakes are released, the vehicle can be moved freely (pushed or towed). Do not engage “N” while driving except to coast when the vehicle is in danger of skidding (e.g. on icy roads, see page 250 for winter driving instructions).

**Important!**

Coasting the vehicle, or driving for any other reason with selector lever in “N” can result in transmission damage that is not covered by the Mercedes-Benz Limited Warranty.

- D** The transmission automatically upshifts through 5th gear. Position “D” provides optimum driving characteristics under all normal operating conditions.

**Gear selection for special circumstances**

The transmission gear ranges for special circumstances can be selected by pressing the selector lever to the right or the left with the selector lever in position “D”.

The gear range currently selected is highlighted in the instrument cluster display.

Briefly press selector lever in the  direction: The transmission downshifts, one gear at a time, in the order “4”, “3”, “2”, “1”.

Press and hold selector lever in the  direction: The selector lever position display will switch to the gear range currently selected by the automatic transmission.

The transmission will only shift down one gear if the gear range currently selected has already shifted to its highest possible gear.

Briefly press selector lever in the  direction: The transmission will shift from the current gear range to the next higher gear range. If the transmission is already in gear range “D”, an additional upshift of one gear is possible.

Press and hold selector lever in the **+** direction:  
The transmission will shift from the current gear directly to gear range “D”.

### **Warning!**

**On slippery road surfaces, never downshift in order to obtain braking action. This could result in drive wheel slip and reduced vehicle control. Your vehicle’s ABS will not prevent this type of loss of control.**

### **Important!**

With transmission in gear range “D”, “4” or “3”, upshifting from 1st to 2nd to 3rd gear is delayed depending on vehicle speed and engine temperature. This allows the catalytic converter to heat up more quickly to operating temperatures. During the brief warm-up period this delayed upshift and increased engine noise might be perceived as a malfunction. However, neither the engine nor transmission are negatively affected by this mode of operation.

The delayed upshift is effective with vehicle speeds below 31 mph (50 km/h) at partial throttle and engine temperatures below 95°F (35°C).

To avoid overrevving the engine when the selector lever is moved to a lower gear range, the transmission will not shift to a lower gear, if the engine’s revolutions per minute limit would be exceeded. In this case there will be no downshift, even when the vehicle speed reaches the engine’s rpm limit of that gear, e.g. by applying the service brakes.

To prevent the engine from laboring at low RPM when driving uphill gradients or with your vehicle heavily loaded, the automatic transmission will downshift when necessary to maintain engine RPM within the best torque range.

**Automatic transmission****240**

Gear ranges:

- 4** Upshift through 4th gear only. Suitable for performance driving.
- 3** Upshift through 3rd gear only. Suitable for moderately steep hills. Since the transmission does not shift higher than 3rd gear, this gear selection will allow use of the engine's braking power downhill.

- 2** Upshift through 2nd gear only. For driving in mountainous regions or under extreme operating conditions. This gear selection will allow use of the engine's braking power when descending steep grades.
- 1** Use this position, which makes maximum use of the engine's braking effect, while descending very steep or lengthy downgrades and only at speeds below 40 mph (60 km/h).

## Program mode selector switch



The transmission is provided with a selector switch (1) for Standard “S” and Winter/Wet (snow and ice) “W” program modes.

The program mode currently selected is indicated in the gear range indicator display.

## S Standard mode

Press switch. “S” is displayed in the gear range indicator display, see page 237. Use this mode for all regular driving.

The vehicle starts out in 1st gear.

### Accelerator Operation:

Fast on = depressing the accelerator pedal quickly (not into kickdown position) while driving continuously, rather than depressing the accelerator pedal in the usual manner, will cause the automatic transmission to shift down into a lower gear. This gear shifting process is dependent on the current vehicle speed.

Fast off = there will be no upshift when releasing the accelerator pedal quickly, e.g. using the engine’s braking power during performance driving.

**Automatic transmission**

242

**W** Winter/Wet (snow and ice) mode

Press switch. “W” is displayed in the gear range indicator display, see page 237. The vehicle starts out in 2nd gear, except with selector lever in 1st gear, or with accelerator pedal in kick-down position.

The “W” mode helps to improve traction and driving stability of the vehicle.

The gear shifting process occurs at lower vehicle and engine speeds than in the “S” program mode.

**Caution!**

Never change the program mode when the selector lever is out of position “P”. It could result in a change of driving characteristics for which you may not be prepared.

**Important!**

Always be certain of the program mode selected since the vehicle driving characteristics change with the selection of the program mode.

Dependent on the program mode selector switch position “S” or “W” and the gear selector lever in position “R”, the ratio of power transmission changes.

**Emergency operation  
(Limp home mode)**

If vehicle acceleration worsens or the transmission no longer shifts, the transmission is most likely operating in Limp Home Mode which engages when there is a malfunction of the transmission. This condition may be accompanied by the “CHECK ENGINE” malfunction indicator lamp in the instrument cluster coming on.

In this mode only the 2nd gear or reverse gear can be activated.

To engage 2nd gear or reverse:

1. Stop the vehicle.
2. Move selector lever to position “P”.
3. Turn off the engine.
4. Wait approximately 10 seconds.
5. Restart the engine.
6. Move selector lever to position “D” (for 2nd gear), or move selector lever to position “R” (for reverse gear).

Have the transmission checked at your authorized Mercedes-Benz Center as soon as possible.

## Parking brake



To engage, firmly depress parking brake pedal. When the electronic key is in starter switch position 2, the brake warning lamp in the instrument cluster should come on brightly.

To release the parking brake, pull handle on instrument panel. The brake warning lamp in the instrument cluster should go out.

A warning sounds and the parking brake warning message appears in the multifunction display (see page 279), if you start to drive without having released the parking brake.

Also see brake warning lamp on page 270.

### Warning!

**When leaving the vehicle always remove the electronic key from the starter switch, and lock the vehicle. Do not leave children unattended in the vehicle, or with access to an unlocked vehicle. Children could release the parking brake, which could result in an accident or serious injury.**



## Driving instructions

### Drive sensibly – Save Fuel

Fuel consumption, to a great extent, depends on driving habits and operating conditions.

To save fuel you should:

- keep tires at the recommended inflation pressures,
- remove unnecessary loads,
- remove roof rack when not in use,
- allow engine to warm up under low load use,
- avoid frequent acceleration and deceleration,
- have all maintenance work performed at regular intervals by an authorized Mercedes-Benz Center.

Fuel consumption is also increased by driving in cold weather, in stop-and-go traffic, on short trips and in hilly country.

## Drinking and driving

### Warning!

**Drinking or taking drugs and driving can be a very dangerous combination. Even a small amount of alcohol or drugs can affect your reflexes, perceptions and judgement.**

**The possibility of a serious or even fatal accident is sharply increased when you drink or take drugs and drive.**

**Please don't drink or take drugs and drive or allow anyone to drive after drinking or taking drugs.**

## Pedals

### Warning!

**Keep driver's foot area clear at all times. Objects stored in this area may impair pedal movement.**

## Power assistance

### Warning!

**When the engine is not running, the brake and steering systems are without power assistance. Under these circumstances, a much greater effort is necessary to stop or steer the vehicle.**

## Brakes

### Warning!

**After driving in heavy rain for some time without applying the brakes or through water deep enough to wet brake components, the first braking action may be somewhat reduced and increased pedal pressure may be necessary to obtain expected braking effect. Be sure to maintain a safe distance from vehicles in front.**

Resting your foot on the brake pedal will cause excessive and premature wear of the brake pads.

It can also result in the brakes overheating thereby significantly reducing their effectiveness. It may not be possible to stop the vehicle in sufficient time to avoid an accident.

The condition of the parking brake system is checked each time the vehicle is in the shop for the required maintenance service.

If the parking brake is released and the brake warning lamp in the instrument cluster stays on, the brake fluid level in the reservoir is too low.

Brake pad wear or a leak in the system may be the reason for low brake fluid in the reservoir.

Have the brake system inspected at an authorized Mercedes-Benz Center immediately.

All checks and service work on the brake system should be carried out by an authorized Mercedes-Benz Center.

Install only brake pads and brake fluid recommended by Mercedes-Benz.

### Warning!

**If other than recommended brake pads are installed, or other than recommended brake fluid is used, the braking properties of the vehicle can be degraded to an extent that safe braking is substantially impaired. This could result in an accident.**

## Driving instructions

246

**Caution!**

When driving down long and steep grades, relieve the load on the brakes by shifting into a lower gear to use the engine's braking power. This helps prevent overheating of the brakes and reduces brake pad wear.

After hard braking, it is advisable to drive on for some time, rather than immediately parking, so the air stream will cool down the brakes faster.

**Driving off**

Apply the service brakes to test them briefly after driving off. Perform this procedure only when the road is clear of other traffic.

Warm up the engine smoothly. Do not place full load on the engine until the operating temperature has been reached.

When starting off on a slippery surface, do not allow one drive wheel to spin for an extended period with the ESP switched off. Doing so may cause serious damage to the drive train which is not covered by the Mercedes-Benz Limited Warranty.

**Parking****Warning!**

**To reduce the risk of personal injury as a result of vehicle movement, before turning off the engine and leaving the vehicle always:**

1. **Keep right foot on service brake pedal.**
2. **Firmly depress parking brake pedal.**
3. **Move the selector lever to position "P" (manual transmission: first or reverse gear).**
4. **Slowly release service brake pedal.**
5. **Turn front wheels towards the road curb.**
6. **Turn the electronic key to starter switch position 0 and remove.**
7. **Take the electronic key and lock vehicle when leaving.**

### Important!

It is advisable to set the parking brake whenever parking or leaving the vehicle. In addition, move selector lever to position “P” (manual transmission: first or reverse gear). When parking on hills, always set the parking brake.

### Tires

#### Warning!

**If you feel a sudden significant vibration or ride disturbance, or you suspect that possible damage to your vehicle has occurred, you should turn on the hazard warning flashers, carefully slow down, and drive with caution to an area which is a safe distance from the roadway.**

**Inspect the tires and under the vehicle for possible damage. If the vehicle or tires appear unsafe, have it towed to the nearest Mercedes-Benz Center or tire dealer for repairs.**

Tread wear indicators (TWI) are required by law. These indicators are located in six places on the tread circumference and become visible at a tread depth of approximately  $\frac{1}{16}$  in (1.5 mm), at which point the tire is considered worn and should be replaced.

The tread wear indicator appears as a solid band across the tread.

## Driving instructions

248

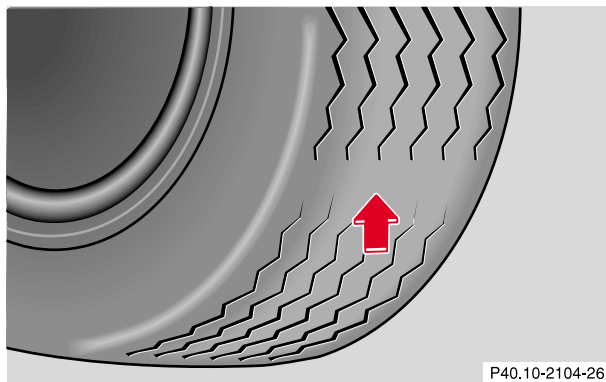

P40.10-2104-26

**Warning!**

**Do not allow your tires to wear down too far. As tread depth approaches  $\frac{1}{16}$  in (1.5 mm), the adhesion properties on a wet road are sharply reduced.**

**Depending upon the weather and/or road surface (conditions), the tire traction varies widely.**

Specified tire pressures must be maintained. This applies particularly if the tires are subjected to high loads (e.g. high speeds, heavy loads, high ambient temperatures).

**Warning!**

**Do not drive with a flat tire. A flat tire affects the ability to steer or brake the vehicle. You may lose control of the vehicle. Continued driving with a flat tire or driving at high speed with a flat tire will cause excessive heat build-up and possibly a fire.**

**Aquaplaning**

Depending on the depth of the water layer on the road, aquaplaning may occur, even at low speeds and with new tires. Reduce vehicle speed, avoid track grooves in the road and apply brakes cautiously in the rain.

## Tire traction

The safe speed on a wet, snow covered or icy road is always lower than on a dry road.

You should pay particular attention to the condition of the road whenever the outside temperatures are close to the freezing point.

### Warning!

**If ice has formed on the road, tire traction will be substantially reduced. Under such weather conditions, drive, steer and brake with extreme caution.**

We recommend M+S rated radial-ply tires for the winter season for all four wheels to insure normal balanced handling characteristics. On packed snow, they can reduce your stopping distance as compared with summer tires. Stopping distance, however, is still considerably greater than when the road is not snow or ice covered.

## Tire speed rating

Vehicles without Sport Package:

Your vehicle is factory equipped with “H”-rated tires, which have a speed rating of 130 mph (210 km/h).

An electronic speed limiter prevents your vehicle from exceeding the speed rating.

### Warning!

**Even when permitted by law, never operate a vehicle at speeds greater than the maximum speed rating of the tires.**

**Exceeding the maximum speed for which tires are rated can lead to sudden tire failure causing loss of vehicle control and resulting in personal injury and possible death.**

**Snow chains**

Use only snow chains that are tested and recommended by Mercedes-Benz. Your authorized Mercedes-Benz Center will be glad to advise you on this subject.

Chains should only be used on the rear wheels. Follow the manufacturer's mounting instructions.

Snow chains should only be driven on snow covered roads at speeds not to exceed 30 mph (50 km/h). Remove chains as soon as possible when driving on roads without snow.

When driving with snow chains, press the ESP control switch to OFF, refer to page 262.

**Winter driving instructions**

The most important rule for slippery or icy roads is to drive sensibly and to avoid abrupt acceleration, braking and steering maneuvers. Do not use the cruise control system under such conditions.

When the vehicle is in danger of skidding, move selector lever to position "N" or in case of manual transmission declutch. Try to keep the vehicle under control by corrective steering action.

Road salts and chemicals can adversely affect braking efficiency. Increased pedal force may become necessary to produce the normal brake effect. We therefore recommend depressing the brake pedal periodically when traveling at length on salt-strewn roads. This can bring road salt impaired braking efficiency back to normal. A prerequisite is, however, that this be done without endangering other drivers on the road.

If the vehicle is parked after being driven on salt treated roads, the braking efficiency should be tested as soon as possible after driving is resumed while observing the safety rules in the previous paragraph.

### **Warning!**

**If the vehicle becomes stuck in snow, make sure that snow is kept clear of the exhaust pipe and from around the vehicle with engine running. Otherwise, deadly carbon monoxide (CO) gases may enter vehicle interior resulting in unconsciousness and death.**

**To assure sufficient fresh air ventilation, open a window slightly on the side of the vehicle not facing the wind.**

### **Winter driving**

Have your vehicle winterized at your authorized Mercedes-Benz Center before the onset of winter.

- Change the engine oil if the engine contains an oil which is not approved for winter operation. For viscosity (SAE/CCMC class) and filling quantity, see page 357.
- Check engine coolant anticorrosion/antifreeze concentration.
- Additive for the windshield washer and headlamp cleaning system: Add MB Concentrate "S" to a premixed windshield washer solvent/antifreeze which is formulated for below freezing temperatures, see page 302.
- Test battery: Battery capacity drops with decreasing ambient temperature. A well charged battery helps to ensure that the engine can be started, even at low ambient temperatures.



## Driving instructions

252

- **Tires:** We recommend M+S rated radial-ply tires on all four wheels for the winter season. Observe permissible maximum speed for M+S rated radial-ply tires and the legal speed limit.

## Note:

In winter operation, the maximum effectiveness of the antilock brake system (ABS) and electronic stability program (ESP) can only be achieved with M+S rated radial-ply tires and/or snow chains recommended by Mercedes-Benz. Snow chains maximize performance.

**Block heater** (Canada only)

The engine is equipped with a block heater.

The electrical cable may be installed at your authorized Mercedes-Benz Center.

**Deep water****Caution!**

Do not drive through flooded areas or water of unknown depth.

If you must drive through deep water, drive slowly to prevent water from entering the engine compartment or passenger compartment, being ingested by the air intake, possibly causing damage to electrical components or wiring, to engine or transmission that is not covered by the Mercedes-Benz Limited Warranty.

## Passenger compartment

### **Warning!**

**Always fasten items being carried as securely as possible.**

**In an accident, during hard braking or sudden maneuvers, loose items will be thrown around inside the vehicle, and cause injury to vehicle occupants unless the items are securely fastened in the vehicle.**

**The trunk is the preferred place to carry objects.**

## Traveling abroad

Abroad, there is a widely-spread Mercedes-Benz service network at your disposal. If you plan to travel into areas which are not listed in the index of your Mercedes-Benz Center directory, you should request pertinent information from your authorized Mercedes-Benz Center.

## Driving systems

254

## Cruise control

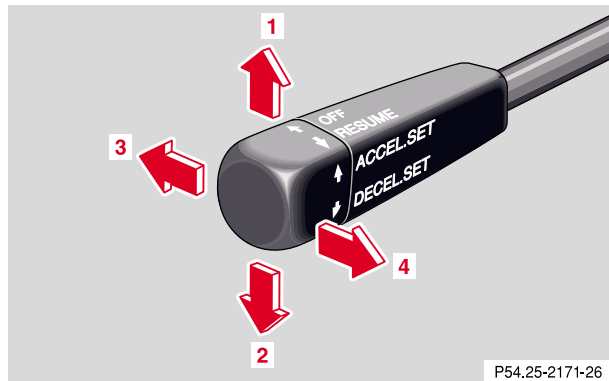

The cruise control allows you to drive in a more relaxed manner, for example over long distances, as it automatically maintains the set speed by actively regulating the throttle setting.

Any given speed above approximately 25 mph (40 km/h) can be maintained with the cruise control by operating the lever.

- 1 Accelerate and set:  
Lift lever briefly to set speed. Hold lever up to accelerate.
- 2 Decelerate and set:  
Depress lever briefly to set speed.  
Hold lever down to decelerate.

Normally the vehicle is accelerated to the desired speed with the accelerator.

Speed is set by briefly pushing the lever to position 1 or 2. The accelerator can then be released.

The speed can be increased (e.g. for passing) by using the accelerator. After the accelerator is released, the previously set speed will be resumed automatically.

If a set speed is to be increased or decreased slightly, e. g. to adapt to the traffic flow, hold lever in position 1 or 2 until the desired speed is reached, or briefly tip the lever in the appropriate direction for increases or decreases in 0.6 mph (1 km/h) increments. When the lever is released, the newly set speed remains.

### 3 Canceling

To cancel the cruise control, briefly push lever to position 3.

When you step on the brake pedal or the vehicle speed drops below approximately 25 mph (40 km/h), for example when driving upgrade, the cruise control will be canceled.

If the cruise control cancels by itself and remains inoperative until the engine is restarted, have the system checked at your authorized Mercedes-Benz Center as soon as possible.

### 4 Resume

If the lever is briefly pushed to position 4 when driving at a speed exceeding approximately 25 mph (40 km/h), the vehicle resumes the speed which was set prior to the cancellation of the cruise control.

The last memorized speed is canceled when the electronic key in the starter switch is turned to position 1 or 0.

#### **Important!**

Moving gear selector lever to position “N” switches the cruise control off.

**Warning!**

**Only use the cruise control if the traffic and weather conditions make it advisable to travel at a steady speed.**

- **The use of cruise control can be dangerous on winding roads or in heavy traffic because conditions do not allow safe driving at a steady speed.**
- **The use of cruise control can be dangerous on slippery roads. Rapid changes in tire adhesion can result in wheel spin and loss of control.**

**The “Resume” function should only be operated if the driver is fully aware of the previously set speed and wishes to resume this particular preset speed.**

## Notes:

If the engine does not brake the vehicle sufficiently while driving on a downgrade, the speed you set on the cruise control may be exceeded. In this case the following will assist in maintaining the set cruise controlled speed:

Vehicles with automatic transmission:

Downshift occurs (max. to 3rd gear) to maintain the set cruise controlled speed by using the engine's braking power.

As soon as the grade eases, the automatic transmission shifts up again dependent on the selector lever position.

Vehicles with manual transmission:

The set cruise controlled speed is switched off when declutching exceeds four seconds during downshifting a gear.

Nevertheless, in some cases you may have to step on the brake pedal to slow down. In this case the cruise control is switched off.

Use the lever to resume the previously set speed.

## Brake assist system (BAS)

### Warning!

**BAS cannot prevent the natural laws of physics from acting on the vehicle, nor can it increase braking efficiency beyond that afforded by the condition of the vehicle brakes and tires or the traction afforded. The BAS cannot prevent accidents, including those resulting from excessive speed in turns, following another vehicle too closely, or aquaplaning. Only a safe, attentive, and skillful driver can prevent accidents. The capabilities of a BAS equipped vehicle must never be exploited in a reckless or dangerous manner which could jeopardize the user's safety or the safety of others.**

The BAS is designed to maximize the vehicle's braking capability during emergency braking maneuvers by having maximum power boost applied to the brakes more quickly in emergency braking conditions than might otherwise be afforded solely by the driver's braking style. This can help reduce braking distances over what ordinary driving and braking style might do. The BAS complements the antilock brake system (ABS).

Applying the brakes very quickly results in maximum BAS assistance.

To receive the benefit of the system you must apply continuous full braking power during the stopping sequence. Do not reduce brake pedal pressure.

Once the brake pedal is released, the BAS is deactivated.

If the BAS warning message is displayed, a malfunction has been detected in the system. The brake system functions in the usual manner, but without BAS.

With the ABS malfunctioning, the BAS is also switched off.

If a BAS warning message is displayed, have the BAS checked at your authorized Mercedes-Benz Center as soon as possible.

### Antilock brake system (ABS)

#### Warning!

**Do not pump the brake pedal, rather use firm, steady brake pedal pressure. Pumping the brake pedal defeats the purpose for ABS and significantly reduces braking effectiveness.**

#### Important!

The ABS improves steering control of the vehicle during hard braking maneuvers.

The ABS prevents the wheels from locking up above a vehicle speed of approximately 5 mph (8 km/h) independent of road surface conditions.

At the instant one of the wheels is about to lock up, a slight pulsation can be felt in the brake pedal, indicating that the ABS is in the regulating mode. Keep firm and steady pressure on the brake pedal while experiencing the pulsation.

Continuous steady brake pedal pressure results in applying the advantages of the ABS, namely braking power and ability to steer the vehicle.

In the case of an emergency brake maneuver keep continuous full pressure on the brake pedal. In this manner only can the ABS be most effective.

On slippery road surfaces, the ABS will respond even with light brake pedal pressure because of the increased likelihood of locking wheels. The pulsating brake pedal can be an indication of hazardous road conditions and functions as a reminder to take extra care while driving.

## ABS control

The ABS malfunction indicator lamp  in the instrument cluster comes on with the electronic key in starter switch position 2 and should go out with the engine running.

When the ABS malfunction indicator lamp in the instrument cluster comes on while the engine is running, it indicates that the ABS has detected a malfunction and has switched off. In this case, the brake system functions in the usual manner, but without antilock assistance.

For ABS malfunction indicator lamp, see page 272.

With the ABS malfunctioning, the BAS and ESP are also switched off. Both malfunction indicator lamps come on with the engine running.

If the charging voltage falls below 10 volts, the malfunction indicator lamp comes on and the ABS is switched off. When the voltage is above this value again, the malfunction indicator lamp should go out and the ABS is operational.

If the ABS malfunction indicator lamp stays illuminated, have the system checked at your authorized Mercedes-Benz Center as soon as possible.

### Warning!

**ABS cannot prevent the natural laws of physics from acting on the vehicle, nor can it increase braking or steering efficiency beyond that afforded by the condition of the vehicle brakes and tires or the traction afforded. The ABS cannot prevent accidents, including those resulting from excessive speed in turns, following another vehicle too closely, or aquaplaning. Only a safe, attentive, and skillful driver can prevent accidents. The capabilities of a ABS equipped vehicle must never be exploited in a reckless or dangerous manner which could jeopardize the user's safety or the safety of others.**

Note:

To alert following vehicles to slippery road conditions you discover, operate your hazard warning flashers as appropriate.



### Electronic stability program (ESP)

#### Warning!

**ESP cannot prevent the natural laws of physics from acting on the vehicle, nor can it increase the traction afforded. The ESP cannot prevent accidents, including those resulting from excessive speed in turns, or aquaplaning. Only a safe, attentive, and skillful driver can prevent accidents. The capabilities of an ESP equipped vehicle must never be exploited in a reckless or dangerous manner which could jeopardize the user's safety or the safety of others.**

The ESP enhances directional control and reduces driving wheel spin of the vehicle under various driving conditions.

Over/understeering of the vehicle is counteracted by applying brakes to the appropriate wheel to create a countervailing vehicle movement. Engine torque is also limited. The ESP warning lamp, located in the speedometer dial, starts to flash when ESP is in operation.

#### Important!

If the ESP warning lamp  flashes:

- During take-off apply as little throttle as possible.
- While driving ease up on the accelerator.
- Adapt your speed and driving to the prevailing road conditions.
- Do not switch off the ESP.

#### Caution!

If the vehicle is towed with the front axle raised (see page 321, "Towing the vehicle"), the engine must be shut off (electronic key in starter switch position 0 or 1). Otherwise, the ESP will immediately be engaged and will apply the rear wheel brakes.

Notes:

The yellow ESP warning lamp  in the speedometer dial comes on with the electronic key in starter switch position 2. It should go out with the engine running.

If the ESP warning message is displayed, a malfunction has been detected in the system. Pressing the accelerator pedal will require greater effort. Only partial engine output will be available.

Have the ESP checked at your authorized Mercedes-Benz Center as soon as possible.

For ESP warning message, see page 273.

With the ABS malfunctioning, the ESP is also switched off.

Driving the vehicle with varied size tires will cause the wheels to rotate at different speeds, therefore the ESP may activate (yellow ESP warning lamp in speedometer dial comes on). For this reason, all wheels, including the spare wheel, must have the same tire size.

When testing the parking brake on a brake test dynamometer, the engine must be shut off. Otherwise, the ESP will immediately be engaged and will apply the rear wheel brakes.

In winter operation, the maximum effectiveness of the ESP is only achieved with Mercedes-Benz recommended M+S rated radial-ply tires and/or snow chains.

### **Synchronizing ESP**

If the power supply was interrupted (battery disconnected or empty), the ESP warning message may be displayed with the engine running.

Turn steering wheel completely to the left and then to the right. The ESP warning message should go out.

## Driving systems

262

## ESP control switch





ESP control switch located on center console.

**1** Press to switch ESP off

ESP warning lamp  in located in speedometer dial comes on.

**2** Press to switch ESP on

ESP warning lamp  in located in speedometer dial goes out.

To improve the vehicle's traction when driving with snow chains, or starting off in deep snow, sand or gravel, switch off ESP by pressing the upper half (1) of the ESP switch. The ESP warning lamp  located in the speedometer dial, is continuously illuminated.

**Warning!**

**When the ESP warning lamp is illuminated continuously, the ESP is switched off.**

**Adapt your speed and driving to the prevailing road conditions.**

With the ESP system switched off, the engine torque reduction feature is cancelled. Therefore, the enhanced vehicle stability offered by ESP is unavailable.

Adapt your speed and driving to the prevailing road conditions.

A portion of the ESP system remains active, even with the switch in the OFF position.

If one drive wheel loses traction and begins to spin, the brake is applied until the wheel regains sufficient traction. The traction control engages at vehicle speeds up to approximately 24 mph (40 km/h), and switches off at 50 mph (80 km/h).

Notes:

Avoid spinning of one drive wheel. This may cause serious damage to the drive train which is not covered by the Mercedes-Benz Limited Warranty.

The ESP warning lamp, located in the speedometer dial, starts to flash at any vehicle speed as soon as the tires lose traction and the wheels begin to spin.

To return to the enhanced vehicle stability offered by ESP: press lower half (2) of the switch (the ESP warning lamp in the speedometer dial goes out).

### **Important!**

If the ESP warning lamp flashes:

- During take-off, apply as little throttle as possible.
- While driving, ease up on the accelerator.

## What you should know at the gas station

264

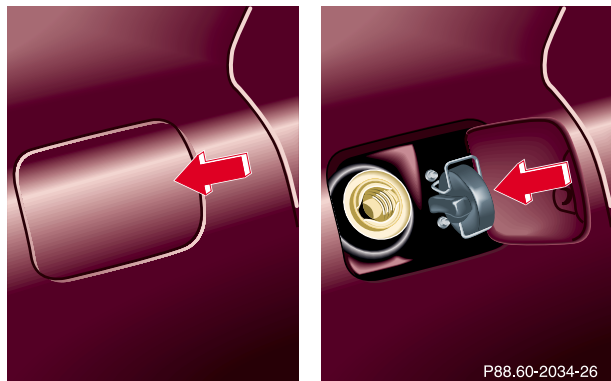
**What you should know at the gas station****Fuel supply****Warning!**

Gasoline is highly flammable and poisonous. It burns violently and can cause serious injury. Whenever you are around gasoline, avoid inhaling fumes and skin contact, extinguish all smoking materials. Never allow sparks, flame or smoking materials near gasoline!

Open flap by pushing near front (arrow). Turn fuel cap to the left and hold on to it until possible pressure in tank has been released, then remove cap. Failure to remove slowly could result in personal injury.

See page 335 for manual release of fuel filler flap.

**Fuel**

To prevent fuel vapors from escaping into open air, fully insert filler nozzle unit.

Only fill fuel tank until the filler nozzle unit cuts out – do not top up or overfill.

**Warning!**

Overfilling of fuel tank may result in creating pressure in the system which could cause a gas discharge such as the gas spraying back out upon removing the filler nozzle which could cause personal injury.

Leaving the engine running and the fuel cap open can cause the “CHECK ENGINE” lamp to illuminate, see page 268 for notes on the “CHECK ENGINE” lamp.

Fuel tank capacity approximately 16.4 US gal (62.0 l). This includes approximately 2.1 US gal (8.0 l) reserve.

Use premium unleaded gasoline:  
Posted Octane Index 91 (Average of 96 RON/86 MON).

### **Engine oil**

Checking oil level, see instructions on page 128 and 300.

Recommended engine oils, see Approved Service Products sheet.

### **Coolant**

For normal replenishing, use water (potable water quality). For further information refer to page 301.

### **Tire pressure**

For tire pressure, refer to tire pressure label inside the fuel filler flap. See page 315 for further details.

### **Spark plugs**

Approved spark plugs, refer to “Technical Data”.

### **Air conditioner**

R-134a refrigerant and special PAG lubricant, refer to “Technical Data”.

### **Bulbs**

High and low beams: H7 (55 W),  
low beam: Xenon (optional)  
fog lamps: H B4 (55 W),  
turn signal lamps,  
front 1156 NA (26.9/5 W/32/4 cp),  
parking and standing lamps, front: W 5W (5 W)  
side marker lamps, front: 5 W/4 cp,  
turn signal lamps, rear: PY 21 W bulb (yellow),  
stop lamps: P 21 W/32 cp bulb,  
rear fog lamp, driver’s side: P 21 W/32 cp bulb,  
tail, parking, standing and  
side marker lamp: R 5 W/4 cp,  
backup lamps: 21 W/32 cp,  
license plate lamps: 5 W/4 cp

Check regularly and before a long trip

266

**Check regularly and before a long trip**

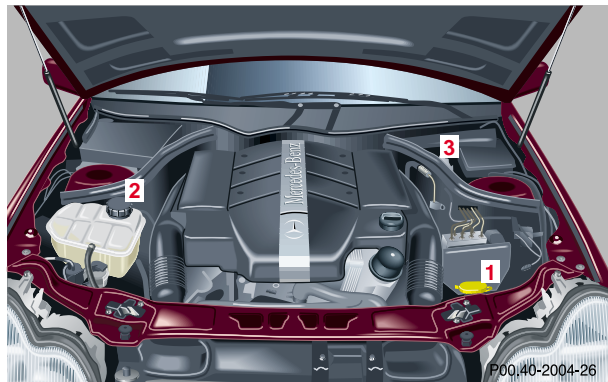

**1 Windshield washer and headlamp cleaning system**

For refilling reservoir see page 302.

**2 Coolant level,**  
see “Coolant level” on page 301

**3 Brake fluid,**  
see “Brake fluid” on page 357

Opening hood, see page 297.

**Vehicle lighting:** Check function and cleanliness. For replacement of light bulbs, see “Exterior lamps” on page 326.

Exterior lamp switch, see page 130.

## Instrument cluster display

Malfunction and indicator lamps in the instrument cluster .....	268
On-board diagnostic system .....	268
Check engine malfunction indicator lamp .....	268
Brake warning lamp .....	270
Supplemental restraint system (SRS) indicator lamp .....	271
Fuel reserve warning .....	271
ABS malfunction indicator lamp .....	272
Electronic stability program (ESP) – warning lamp .....	273
Seat belt nonusage warning lamp .....	273

Malfunction and indicator lamp in the center console .....	273
AIRBAG OFF indicator lamp ....	273
Malfunction and warning messages in the multifunction display ....	274
DISPLAY DEFECTIVE .....	275
BATTERY / ALTERNATOR .....	276
ANTILOCK BRAKE SYSTEM ....	277
BRAKE ASSIST .....	277
BRAKE LINING WEAR .....	278
BRAKE FLUID .....	278
PARKING BRAKE .....	279
SEAT BELT SYSTEM .....	279
ELEC. STABIL. PROG. (Electronic stability program) .	280
COOLANT (coolant level) .....	281

COOLANT (coolant temperature) .....	282
ENGINE OIL LEVEL .....	283
LIGHTING SYSTEM .....	284
LIGHT SENSOR .....	286
DOOR .....	286
TRUNK OPEN .....	287
HOOD .....	287
TELEPHONE – FUNCTION .....	288
TELE AID .....	288
WASHER FLUID .....	289
RESTRAINT SYSTEM .....	290
KEY .....	290
FUEL RESERVE .....	291
UNDERVOLTAGE .....	291
STEER. WHEEL ADJUST. ....	292
ENTRANCE POSITION .....	292



### Malfunction and indicator lamps in the instrument cluster

General information:

If a bulb in the instrument cluster fails to light up during the bulb self-check when turning the electronic key in steering lock to position 2, have it checked and replaced if necessary.

#### Emission control

Certain systems of the engine serve to keep the toxic components of the exhaust gases within permissible limits required by law.

These systems, of course, will function properly only when maintained strictly according to factory specifications. Any adjustments on the engine should, therefore, be carried out only by authorized Mercedes-Benz Center qualified technicians. Engine adjustments should not be altered in any way. Moreover, the specified service jobs must be carried out regularly according to Mercedes-Benz servicing requirements. For details refer to the Service Booklet.

#### Warning!

**Inhalation of exhaust gas is hazardous to your health. All exhaust gas contains carbon monoxide, and inhaling it can cause unconsciousness and lead to death.**

**Do not run the engine in confined areas (such as a garage) which are not properly ventilated. If you think that exhaust gas fumes are entering the vehicle while driving, have the cause determined and corrected immediately. If you must drive under these conditions, drive only with at least one window fully open.**

#### On-board diagnostic system

##### Check engine malfunction indicator lamp



Engine malfunction indicator lamp. If the “CHECK ENGINE” malfunction indicator lamp comes on when the engine is running, it indicates a malfunction of the fuel management system, emission control system, systems which impact emissions, or the fuel cap is not closed tight (check the fuel cap). If the “CHECK ENGINE” lamp is illuminated continuously and the vehicle is driving normally, you

may still drive the vehicle, however, in all cases, we recommend that you have the system checked at your authorized Mercedes-Benz Center as soon as possible.

If the “CHECK ENGINE” lamp is flashing and/or the vehicle is not driving normally (e.g. malfunction of the fuel management system or running out of fuel), serious damage can occur to the emission system. Please contact your authorized Mercedes-Benz Center immediately.

The Sequential Multiport Fuel Injection (SFI) control module monitors emission control components that either provide input signals to or receive output signals from the control module. Malfunctions resulting from interruptions or failure of any of these components are indicated by the “CHECK ENGINE” malfunction indicator lamp in the instrument cluster and are simultaneously stored in the SFI control module.

If the “CHECK ENGINE” malfunction indicator lamp comes on, have the system checked at your authorized Mercedes-Benz Center as soon as possible.

With some exceptions, the control module switches off the “CHECK ENGINE” malfunction indicator lamp if the condition, causing the lamp to come on, no longer exists during three consecutive cycles.

An on-board diagnostic connector is located in the passenger compartment near to the parking brake pedal, allowing the accurate identification of system malfunctions through the readout of diagnostic trouble codes.

## Malfunction and indicator lamps

270

## Brake warning lamp

BRAKE

Except Canada



Canada only

When the brake warning lamp and message appear while the engine is running, this means:

- there is insufficient brake fluid in the reservoir (engine running and parking brake released), or
- the parking brake is set (engine running).

## Warning!

**Driving with the brake warning lamp illuminated can result in an accident. Have your brake system checked immediately if the brake warning lamp stays on. Don't add brake fluid before checking the brake system. Overfilling the brake fluid reservoir can result in spilling brake fluid on hot engine parts and the brake fluid catching fire. You can be seriously burned.**

## Note:

If you find that the minimum mark on the brake fluid reservoir is reached, have the brake system checked for brake pad thickness and leaks.

## Supplemental restraint system (SRS) indicator lamp

**SRS**

The operational readiness of the airbag system is verified by the indicator lamp “SRS” in the instrument cluster when turning the electronic key in starter switch to position 1 or 2. If no fault is detected, the lamp will go out after approximately 4 seconds; after the lamp goes out, the system continues to monitor the components and circuitry of the airbag system and will indicate a malfunction by coming on again.

### Warning!

**In the event a malfunction of the “SRS” is indicated as outlined above, the “SRS” may not be operational. For your safety, we strongly recommend that you visit an authorized Mercedes-Benz Center immediately to have the system checked; otherwise the “SRS” may not be activated when needed in an accident, which could result in serious or fatal injury, or it might deploy unexpectedly and unnecessarily which could also result in injury.**

See page 65 for notes on airbags, see page 63 for belt tensioners and page 55 for infant and child seat restraint.

## Fuel reserve warning

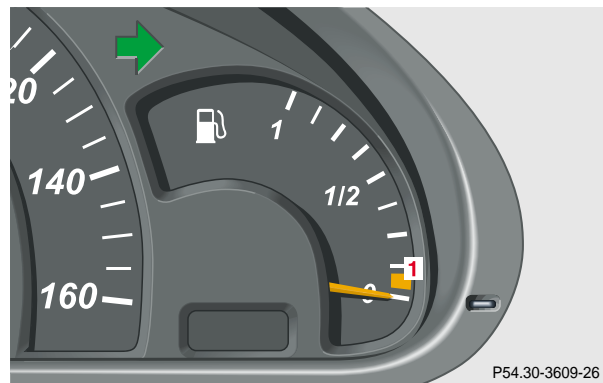

### 1 Fuel reserve indicator

When the warning lamp (1) comes on after starting the engine, or if comes on while driving, it indicates that the fuel level is down to the reserve quantity of approximately 2.1 US gal (8 liters).

See page 264 for notes on refueling the vehicle.

## Malfunction and indicator lamps

272

### ABS malfunction indicator lamp



The ABS malfunction indicator lamp in the instrument cluster comes on with the electronic key in starter switch position 2 and should go out with the engine running.

When the ABS malfunction indicator lamp symbol and warning in the instrument cluster remains illuminated while the engine is running, it indicates that the ABS has detected a malfunction and has switched off. In this case, the brake system functions in the usual manner, but without antilock assistance.

A malfunctioning ABS control unit can possibly affect the operation of other systems (e.g. Navigation, Automatic transmission). Be guided accordingly with respect to the use of those systems and have the system checked at your authorized Mercedes-Benz Center as soon as possible.

With the ABS malfunctioning, the BAS and ESP are also switched off. The malfunction indicator lamps and malfunction messages in the multifunction display come on with the engine running.

If the charging voltage falls below 10 volts, the malfunction indicator lamp comes on and the ABS is switched off. When the voltage is above this value again, the malfunction indicator lamp should go out and the ABS is operational.

Have the system checked at your authorized Mercedes-Benz Center as soon as possible.

See page 258 for notes on antilock brake system (ABS).

## Electronic stability program (ESP) – warning lamp



The yellow ESP warning lamp in the speedometer dial comes on with the electronic key in starter switch position 2.

It should go out with engine running.

If the ESP malfunction indicator lamp remains illuminated with the engine running, a malfunction has been detected in the system. Pressing the accelerator pedal will require greater effort. Only partial engine output will be available.

See electronic stability program (ESP) on page 260 if the warning lamp lights up or flashes when the vehicle is moving.

## Seat belt nonusage warning lamp



With the electronic key in starter switch position 2, the seat belt nonusage warning lamp comes on, and a warning sounds for a short time if the drivers seat belt is not fastened.

After starting the engine, the seat belt nonusage warning lamp blinks for a brief period to remind the driver and passengers to fasten seat belts.

## Malfunction and indicator lamp in the center console

### AIRBAG OFF indicator lamp

The  indicator lamp will light up for approximately 6 seconds when you turn the electronic key in starter switch to position 1 or 2.

It does not light up if there is a fault in the system.

The  indicator lamp stays lit as long as a Baby Smart™ child seat is properly installed on the front passenger seat. It indicates that the front passenger airbag is switched off.

See page 62 for BabySmart™ airbag and its deactivation system.

Baby Smart™ is a trademark of Siemens Automotive Corp.

## Malfunction and warning messages

274

**Malfunction and warning messages in the multifunction display**

Malfunction and warning messages for the following systems will be displayed immediately in the multifunction display.

They are divided into three categories.

Category C1:

Messages of most immediate priority.

These cannot be cleared from the instrument cluster using the reset knob on the instrument cluster (see page 90).

Categories C2 and C3:

Messages of less immediate priority.

These can be cleared from the instrument cluster using the reset knob on the instrument cluster (see page 90) and are then stored in the malfunction message memory. See page 109

Note:

Certain malfunction and warning messages are accompanied by an audible signal.

Malfunction and warning messages in red are always accompanied by an audible signal.

Temporary messages such as “TRUNK OPEN!” will not be stored in the malfunction message memory.

**Warning!**

**All categories of messages contain important information which should be taken note of and, where malfunction indicated, addressed as soon as possible at an authorized Mercedes-Benz Center.**

**Failure to repair condition noted may cause damage not covered by the Mercedes-Benz Limited Warranty, or result in property damage or personal injury.**

## DISPLAY DEFECTIVE (engine control unit)



Line 1	Line 2	C*
VISIT WORKSHOP!	DISPLAY FAULTY	2

\* C = Category, see page 274

This message is displayed to indicate that the information being relayed by the engine control unit is no longer complete. The display for coolant temperature gauge, tachometer, or the cruise control may have failed.

## DISPLAY DEFECTIVE (several systems)



Line 1	Line 2	C*
VISIT WORKSHOP!	DISPLAY FAULTY	2

\* C = Category, see page 274

The displays for several systems have failed. Some systems themselves may also have failed.



## Malfunction and warning messages

276

## BATTERY / ALTERNATOR



Line 1	Line 2	C*
BATTERY/ALTERNATOR	VISIT WORKSHOP!	2

\* C = Category, see page 274

This message indicates a malfunction which must be repaired immediately.

It may indicate that the poly-V-belt has broken. Should this condition occur, the poly-V-belt must be replaced before continuing to operate the vehicle. Otherwise, the engine will overheat due to an inoperative water pump which may result in damage to the engine.

Do not continue to drive the vehicle with this message displayed.

Doing so could result in serious engine damage that is not covered by the Mercedes-Benz Limited Warranty.

## ANTILOCK BRAKE SYSTEM



Line 1	Line 2	C*
ABS SYSTEM	VISIT WORKSHOP!	2
DISPLAY DEFECTIVE	VISIT WORKSHOP! <sup>1</sup>	2

\* C = Category, see page 274

See page 258 for notes on the antilock brake system (ABS).

1 The display or the system is malfunctioning

## BRAKE ASSIST



Line 1	Line 2	C*
BRAKE ASSIST	NOT AVAILABLE!	2
BRAKE ASSIST	VISIT WORKSHOP!	2
DISPLAY DEFECTIVE	VISIT WORKSHOP!	2

\* C = Category, see page 274

A malfunction has been detected in the system. The brake system functions in the usual manner, but without brake assist system (BAS).

See page 257 for notes on the brake assist system (BAS).

## Malfunction and warning messages

278

## BRAKE LINING WEAR



Line 1	Line 2	C*
BRAKE LINING WEAR	VISIT WORKSHOP!	2

\* C = Category, see page 274

When this message appears during braking, it indicates that the brake pads are worn down.

Have the brake system checked at your authorized Mercedes-Benz Center as soon as possible.

## BRAKE FLUID



Line 1	Line 2	C*
BRAKE FLUID	VISIT WORKSHOP!	2

\* C = Category, see page 274

**Warning!**

**Driving with this message displayed can result in an accident. Have your brake system checked immediately. Don't add brake fluid before checking the brake system. Overfilling the brake fluid reservoir can result in spilling brake fluid on hot engine parts and the brake fluid catching fire. You can be seriously burned.**

## PARKING BRAKE



Line 1	Line 2	C*
PARKING BRAKE	ENGAGE BRAKE!	1
PARKING BRAKE	RELEASE BRAKE!	1

\* C = Category, see page 274

## SEAT BELT SYSTEM



Line 1	Line 2	C*
SEAT BELT SYSTEM	VISIT WORKSHOP!	1
PASSENGER SEAT BELT	FASTEN SEAT BELT!	2
DRIVER SEAT BELT	FASTEN SEAT BELT!	2

\* C = Category, see page 274

## Malfunction and warning messages

## 280

**ELEC. STABIL. PROG.  
(Electronic stability program)**

Line 1	Line 2	C*
ELEC. STABIL. PROG.	NOT AVAILABLE! <sup>1, 2, 3, 4</sup>	2
ELEC. STABIL. PROG.	VISIT WORKSHOP! <sup>1, 5</sup>	2
DISPLAY DEFECTIVE	VISIT WORKSHOP! <sup>6</sup>	2

\* C = Category, see page 274

- 1 The enhanced vehicle stability offered by ESP and the torque reduction feature are unavailable.
- 2 This message may be displayed if the power supply was interrupted (battery disconnected or empty). Synchronize ESP, see page 261
- 3 The system is temporarily unavailable. The reason could be that the self-diagnosis has not been completed. The display will clear itself after driving a short distance at more than 12 mph (20 km/h).
- 4 The system is unavailable due to low voltage, e.g. battery not being charged.
- 5 A malfunction has been detected in the system. In case of ESP malfunction the ESP warning lamp in the instrument cluster illuminates and the ESP switch in the center console does not function. If in addition the ABS is malfunctioning, only partial engine output will be available.
- 6 The display or the system is malfunctioning.

## COOLANT (coolant level)

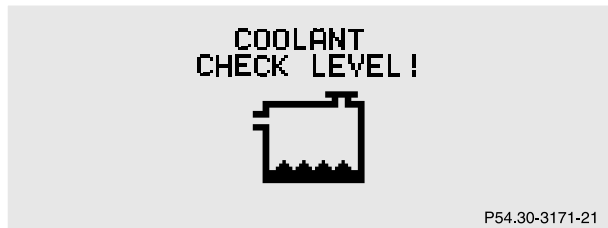

Line 1	Line 2	C*
COOLANT	CHECK LEVEL!	2

\* C = Category, see page 274

When this message appears while driving, the coolant level has dropped below the required level. If no leaks are noticeable and the engine temperature does not increase, continue to drive to the nearest service station and have coolant added to the coolant system.

The low engine coolant level warning should not be ignored. Extended driving with the symbol displayed may cause serious engine damage not covered by the Mercedes-Benz Limited Warranty.

In cases of major or frequent minor coolant loss, have the cooling system checked at your authorized Mercedes-Benz Center as soon as possible.

### Note:

Do not drive without coolant in the cooling system. The engine will overheat causing major engine damage.

Monitor the coolant temperature gauge while driving, see page 124.

See page 302 for instructions on topping up the coolant.

### Warning!

**Do not spill antifreeze on hot engine parts. Antifreeze contains ethylene glycol which may burn if it comes into contact with hot engine parts. You can be seriously burned.**

## Malfunction and warning messages

282

## COOLANT (coolant temperature)

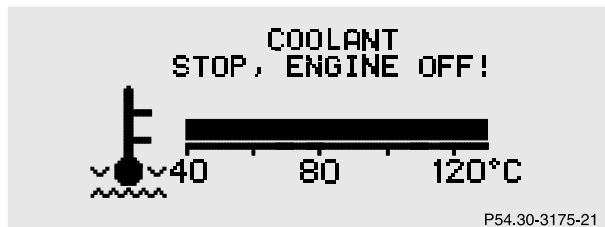

Line 1	Line 2	C*
COOLANT	STOP, ENGINE OFF! <sup>1</sup>	1
COOLANT	VISIT WORKSHOP! <sup>2</sup>	2

\* C = Category, see page 274

- 1 This may indicate that the poly-V-belt has broken. Should this condition occur, the poly-V-belt must be replaced before continuing to operate the vehicle. Otherwise, the engine will overheat due to an inoperative water pump which may result in damage to the engine. Do not continue to drive the vehicle with this message displayed. Doing so could result in serious engine damage that is not covered by the Mercedes-Benz Limited Warranty.
- 2 The cooling fan for the coolant is faulty. Observe the coolant temperature gauge. See page 124

During severe operating conditions and stop-and-go city traffic, the coolant temperature may rise close to 120°C.

The engine should not be operated with the coolant temperature above 120°C. Doing so may cause serious engine damage which is not covered by the Mercedes-Benz Limited Warranty.

**Warning!**

**Driving when your engine is badly overheated can cause some fluids which may have leaked into the engine compartment to catch fire. You could be seriously burned.**

**Steam from an overheated engine can cause serious burns and can occur just by opening the engine hood. Stay away from the engine if you see or hear steam coming from it.**

**Turn off the engine, get out of the vehicle and do not stand near the vehicle until it cools down.**

## ENGINE OIL LEVEL

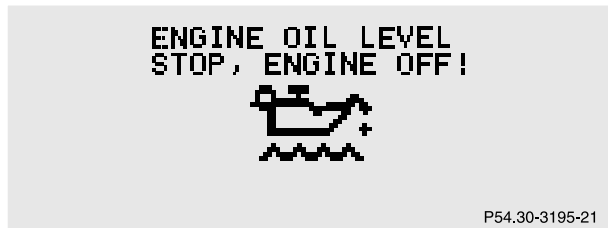

Line 1	Line 2	C*
ENGINE OIL LEVEL	CHECK LEVEL! <sup>1</sup>	2
ENGINE OIL LEVEL	STOP, ENGINE OFF! <sup>2</sup>	1
ENGINE OIL LEVEL	REDUCE OIL LEVEL! <sup>3</sup>	2
ENGINE OIL	VISIT WORKSHOP! <sup>4</sup>	2
ENGINE OIL LEVEL	VISIT WORKSHOP! <sup>5</sup>	2

\* C = Category, see page 274.

1 The engine oil level must be checked immediately. See Engine oil level indicator on page 128.

2 There is no oil in the engine. There is a danger of engine damage.

- 3 There is a risk of damaging the engine or catalytic converter. The engine oil level must be checked immediately. See Engine oil level indicator on page 128.
- 4 The engine oil level has dropped to a critical level. Check the engine oil level immediately. See Engine oil level indicator on page 128 and check the engine for visible leakage (loss of oil). It may be that there is water in the engine oil. Have the engine oil checked.
- 5 The measuring system is malfunctioning.

When the “ENGINE OIL LEVEL – CHECK LEVEL!” message appears while the engine is running and at operating temperature, the engine oil level has dropped to approximately the minimum mark on the dipstick.

When this occurs, the warning will first come on intermittently and then stay on if the oil level drops further.

If no oil leaks are noted, continue to drive to the nearest service station where the engine oil should be topped to the “full” mark on the dipstick with an approved oil.

The engine oil level warnings should not be ignored. Extended driving with the symbol displayed could result in serious engine damage that is not covered by the Mercedes-Benz Limited Warranty.



## Malfunction and warning messages

284

## LIGHTING SYSTEM

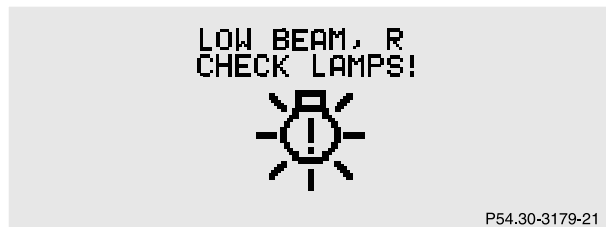

Line 1	Line 2	C*
LOW BEAM,L	CHECK LAMP!	2
LOW BEAM,R	CHECK LAMP!	2
DISPLAY DEFECTIVE	VISIT WORKSHOP! <sup>1</sup>	2
TURN SIGNAL, L	CHECK LAMP!	2
TURN SIGNAL, R	CHECK LAMP!	2
L. TURN SIG. RFLECTR	CHECK LAMP!	2
R. TURN SIG. RFLECTR	CHECK LAMP!	2
TURN SIGNAL F, L	CHECK LAMP!	2

Line 1	Line 2	C*
TURN SIGNAL F, R	CHECK LAMP!	2
BRAKE LIGHT <sup>2</sup>	VISIT WORKSHOP!	2
BRAKE LIGHT, L <sup>3</sup>	CHECK LAMP!	2
BRAKE LIGHT, R <sup>3</sup>	CHECK LAMP!	2
3RD STOP LAMP <sup>3</sup>	CHECK LAMP!	2
HIGH BEAM, L	CHECK LAMP!	2
HIGH BEAM, R	CHECK LAMP!	2
LICENSE PLATE L, L	CHECK LAMP!	2
LICENSE PLATE L, R	CHECK LAMP!	2
LIGHTS	SWITCH OFF LIGHTS!	1
AUTOM. LIGHT ON	REMOVE KEY!	1
FRONT FOG LAMP, L	CHECK LAMP!	2
FRONT FOG LAMP, R	CHECK LAMP!	2
REAR FOG LAMP	CHECK LAMP!	2

Line 1	Line 2	C*
REAR FOGLAMP	SWITCH OFF SUBSTITUTE LAMP ON! <sup>4</sup>	2
REVERSE LIGHT, L	CHECK LAMP!	2
REVERSE LIGHT, R	CHECK LAMP!	2
TAIL LIGHT, L	CHECK LAMP! SUBSTITUTE LAMP ON! <sup>4</sup>	2
TAIL LIGHT, R	CHECK LAMP! SUBSTITUTE LAMP ON! <sup>4</sup>	2
SIDELIGHT, L	CHECK LAMP! SUBSTITUTE LAMP ON! <sup>4</sup>	2
SIDELIGHT, R	CHECK LAMP! SUBSTITUTE LAMP ON! <sup>4</sup>	2

In the case of bulb failures in certain lamps, other lamps will substitute. See page 326 for instructions on replacing bulbs.

\* C = Category, see page 274

- 1 The display or the system is malfunctioning.
- 2 The brake lamps are switching on after a delay or are permanently on – visit workshop immediately.
- 3 The brake lamp comprises several light emitting diodes. The warning message will only appear if all light emitting diodes have stopped working.
- 4 Other bulbs will be brought into use as replacements when certain lamps blow.

## Malfunction and warning messages

286

## LIGHT SENSOR

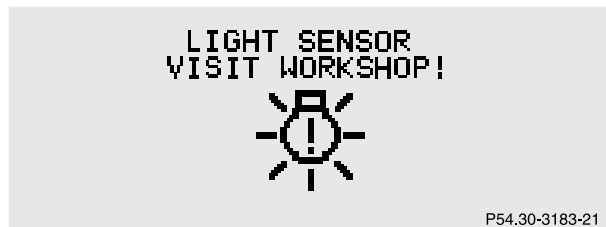

Line 1	Line 2	C*
LIGHT SENSOR	VISIT WORKSHOP!	2

\* C = Category, see page 274

The headlamps will be switched on automatically if the light sensor malfunctions.

The “LIGHTING” setting menu can be set to “MANUAL” in the individual settings. See page 117. It will then be possible to switch the headlamps on and off using the exterior lamp switch. See page 130 for notes on the exterior lamp switch.

## DOOR

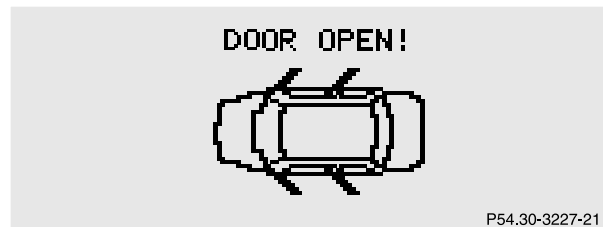

Line 1	Line 2	C*
DOOR OPEN!		1

\* C = Category, see page 274.

## TRUNK OPEN



Line 1	Line 2	C*
TRUNK OPEN!		2

\* C = Category, see page 274

## HOOD

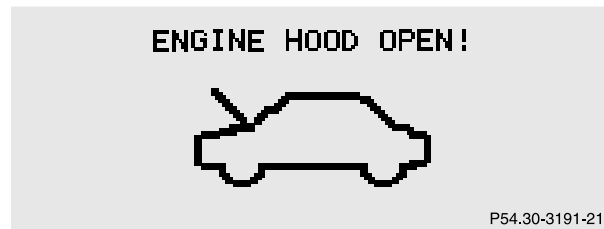

Line 1	Line 2	C*
ENGINE HOOD OPEN!		2

\* C = Category, see page 274.

See page 297 for hood.

## Malfunction and warning messages

288

## TELEPHONE – FUNCTION

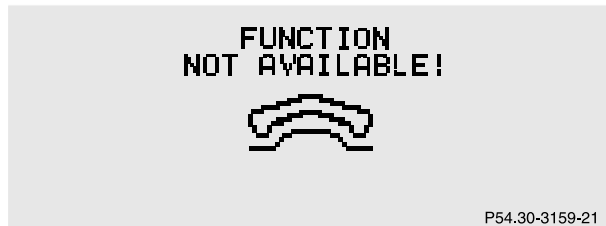

Line 1	Line 2	C*
FUNCTION	NOT AVAILABLE!	3

\* C = Category, see page 274.

The display appears if button  or  on the multifunction steering wheel is pressed and the vehicle is not equipped with a telephone.

## TELE AID



Line 1	Line 2	C*
TELE AID	VISIT WORKSHOP! <sup>1</sup>	1

\* C = Category, see page 274.

- The Tele Aid system consists of three types of response; automatic and manual emergency, roadside assistance and information. With this message displayed, one or more functions may not be available.

See page 220 for notes on the Tele Aid.

If a malfunction is indicated as outlined above, have the system checked at the nearest Mercedes-Benz Center as soon as possible.

## WASHER FLUID



Line 1	Line 2	C*
WASHER FLUID	CHECK LEVEL!	3

\* C = Category, see page 274.

When this message appears while the engine is running, the level of the reservoir has dropped to approximately  $\frac{1}{3}$  of the total volume. The reservoir should be refilled with the prescribed mixture of MB Windshield washer concentrate and water or the concentrate and commercially available premixed windshield washer solvent/antifreeze, depending on ambient temperature, at the next opportunity. The reservoir for the windshield and headlamp washer systems is located in the engine compartment.

See windshield and headlamp washer system on page 302 for instructions on topping up the washer fluid.

## Malfunction and warning messages

290

## RESTRAINT SYSTEM



Line 1	Line 2	C*
RESTRAINT SYSTEM	VISIT WORKSHOP!	1

\* C = Category, see page 274.

See page 55 for notes on the seat belts, and page 65 for notes on the airbags.

## KEY



Line 1	Line 2	C*
REPLACE KEY <sup>1</sup>	VISIT WORKSHOP!	2
AUTOM. LIGHT ON	REMOVE KEY!	1

\* C = Category, see page 274.

<sup>1</sup> Key needs possibly to be replaced.

## FUEL RESERVE

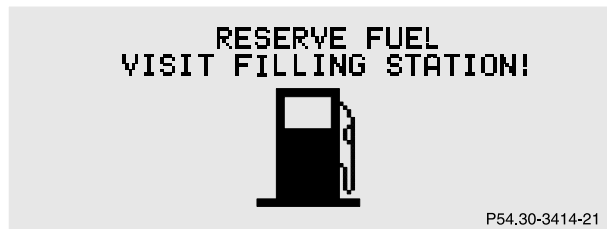

Line 1	Line 2	C*
RESERVE FUEL	VISIT FILLING STATION!	2

\* C = Category, see page 274.

## UNDERVOLTAGE

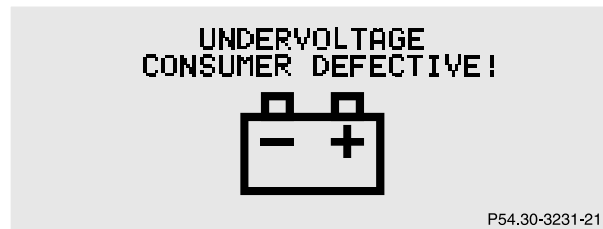

Line 1	Line 2	C*
UNDERVOLTAGE	ENGINE ON!	1
UNDERVOLTAGE	CONSUMER DEFECTIVE!	1

\* C = Category, see page 274.



## Malfunction and warning messages

292

## STEERING WH. ADJUST



Line 1	Line 2	C*
STEERING WH. ADJUST	LOCK!	1

\* C = Category, see page 274.

For locking the manual steering wheel adjustment, see page 77.

## ENTRANCE POSITION



Line 1	Line 2	C*
ENTRANCE POSITION	DO NOT DRIVE!	1

\* C = Category, see page 274.

Wait until the seat and steering wheel have moved to their driving positions. The display will clear when they have done so.

See also page 41 for easy-entry/exit feature.

## Practical hints

First aid kit .....	294	Spare wheel, vehicle tools, storage compartment .....	304	Exterior lamps .....	326
Stowing things in the vehicle .....	294	Vehicle jack .....	305	Replacing bulbs .....	326
Fuses .....	295	Wheels .....	306	Trunk lamp .....	331
Hood .....	297	Tire replacement .....	306	Changing batteries in the electronic main key .....	332
Checking engine oil level .....	300	Rotating wheels .....	307	Synchronizing remote control .....	334
Automatic transmission fluid level .....	301	Spare wheel .....	308	Emergency engine shut-down .....	334
Coolant level .....	301	Changing wheels .....	309	Fuel filler flap, manual release .....	335
Adding coolant .....	302	Tire inflation pressure .....	315	Replacing wiper blade insert .....	337
Windshield and headlamp washer system .....	302	Battery .....	316	Roof rack .....	338
		Jump starting .....	318		
		Towing the vehicle .....	321		
		Transmission selector lever, manually unlocking .....	325		

## First aid kit

294

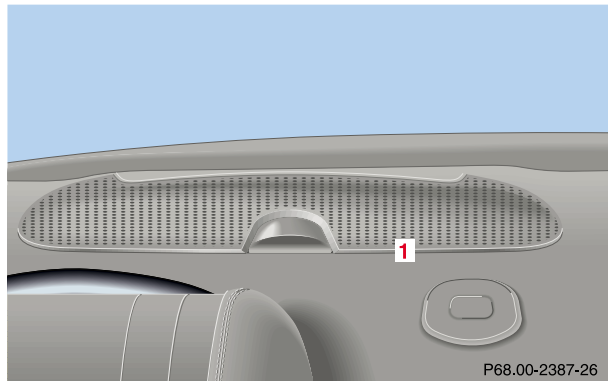
**First aid kit**

The first aid kit is located in the storage space (1) in the shelf below the rear window.

Lift cover. Remove first aid kit.

**Stowing things in the vehicle****Warning!**

To help avoid personal injury during a collision or sudden maneuver, exercise care when stowing things. Put luggage or cargo in the trunk if possible. Do not pile luggage or cargo higher than the seat backs. Do not place anything on the shelf below the rear window.

## Fuses

Most of your vehicle's electrical components are fused with safety fuses. With the exception of the brake lights, all individual lighting system components are electronically fused. Before replacing a blown safety fuse, determine the cause of the short circuit. Always observe amperage and color of fuse.

The circuit for components is protected by a cycled circuit breaker interrupted if too much current is being drawn. The circuit closes automatically after a short time; the circuit is broken again if the malfunction reoccurs.

Always use a new fuse for replacement. Never attempt to repair or bridge a blown fuse.

A fuse chart is located in fuse box (1).

A fuse extractor is located in the auxiliary fuse box in the trunk, see page 296.

## Fuse box in the passenger compartment



### 1 Fuse box in passenger compartment

To gain access to fuse box, pull cover away from fuse box (arrow) and remove rearward.

## Fuses

296

## Fuse box in engine compartment

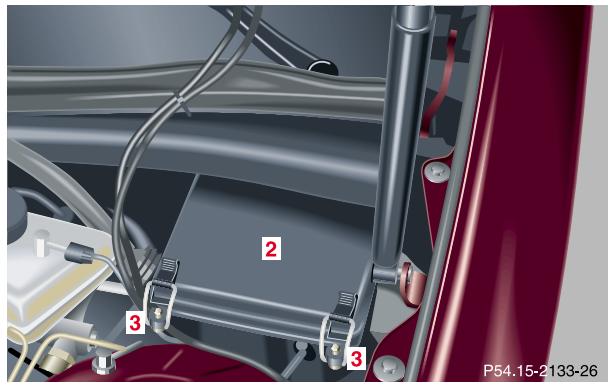

**2** Fuse box in engine compartment, left-hand side

**3** Tabs

To gain access to fuse box:

Release clamps (3) and remove the cover.

To close the fuse box:

Ensure that the sealing rubber is properly positioned when you replace the cover. Press the cover down by hand and secure with clamps (3).

## Auxiliary fuse box in the trunk

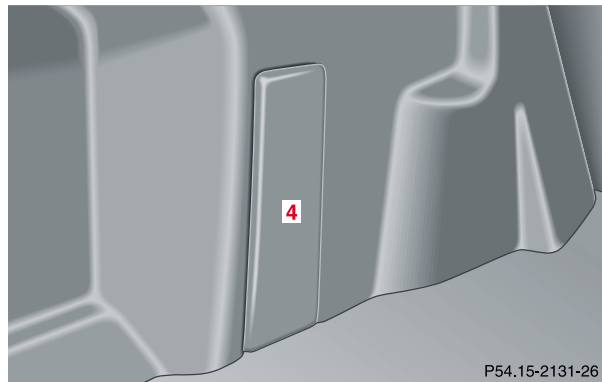

**4** Auxiliary fuse box in left hand side of trunk.

To open:

Remove the cover.

To close:

Press the cover on.

## Hood

### Warning!

To help prevent personal injury, stay clear of moving parts when the hood is open and the engine is running. Be sure the hood is properly closed before driving. When closing hood, use extreme caution not to catch hands or fingers.

The radiator fan may continue to run for approximately 30 seconds or even restart after the engine has been turned off. Stay clear from fan blades.

If you see flames or smoke coming from the engine compartment, or if the coolant temperature gauge indicates that the engine is overheated, do not open the hood. Move away from vehicle and do not open the hood until the engine has cooled. If necessary, call a fire department.

The engine is equipped with a transistorized ignition system. Because of the high voltage it is dangerous to touch any components (ignition coils, spark plug sockets, diagnostic socket) of the ignition system

- with the engine running,
- while starting the engine,
- if ignition is “on” and the engine is turned manually.

## Engine compartment

298

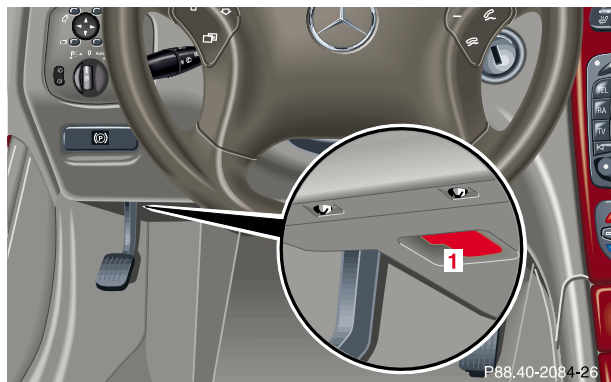

To open:  
To unlock the hood, pull release lever (1) under the driver's side of the instrument panel. At the same time a handle will extend out of the radiator grill.



Pull handle (2) to its stop out of radiator grill and open hood (do not pull up on the handle).

Note:

To avoid damage to the windshield wipers or hood, open the hood only with the wipers in the parked position.

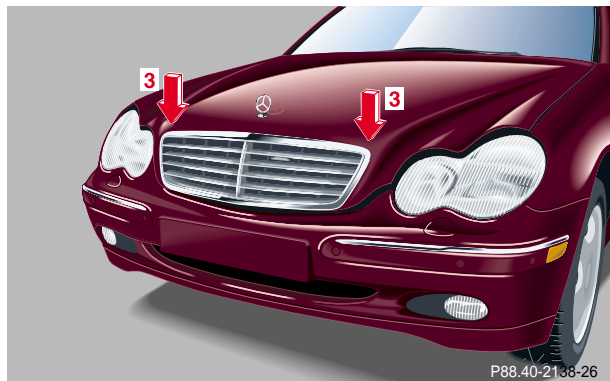

To close:

Lower the hood and let it drop into lock from a height of approximately 1 ft. (30 cm), assisting with hands placed flat on edges of hood (3).

To avoid hood damage, please make sure that hood is fully closed. If not, repeat closing procedure. Do not push down on hood to attempt to fully close it.



## Engine compartment

300

## Checking engine oil level

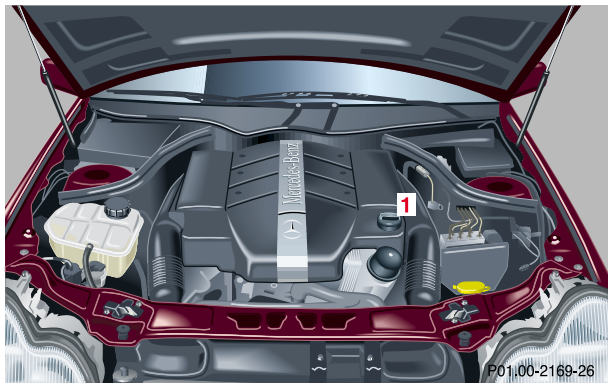
**1** Oil filler cap

To check the engine oil level, park vehicle on level ground, with engine at normal operational temperature.

Check engine oil level approximately 5 minutes after stopping the engine, allowing for the oil to return to the oil pan.

The engine oil level can be checked via the multifunction display in the instrument cluster.

Unscrew the oil filler cap and add oil carefully if you need to top up the oil. Fill quantity between upper and lower dipstick marking level is approximately 2.1 US qt (2.0 l). Re-install oil filler cap.

Do not overfill the engine. Excessive oil must be drained or siphoned. It could cause damage to engine and catalytic converter not covered by the Mercedes-Benz Limited Warranty.

See malfunction and warning messages on page 274 if an engine oil level display appears on the multifunction indicator when the engine is running.

Note:

See page 128 for engine oil level indicator.

### Automatic transmission fluid level

The transmission has a permanent fill of automatic transmission fluid.

Regular automatic transmission fluid level checks and changes are not required. For this reason the dipstick is omitted.

If you notice fluid leaks or gear shifting malfunctions, have your authorized Mercedes-Benz Center check the transmission fluid level.

### Coolant level

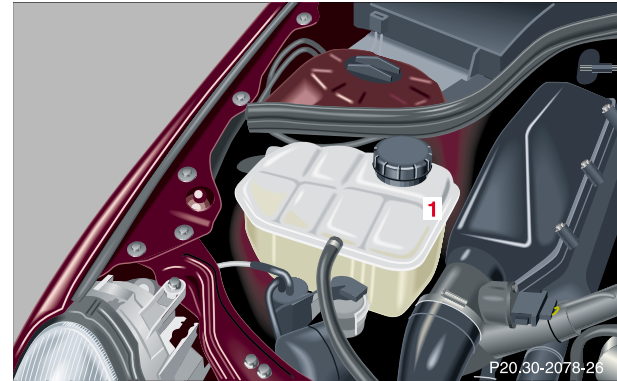

#### 1 Coolant expansion tank

To check the coolant level, the vehicle must be parked on level ground and the engine stopped.

Check coolant level only when coolant is cold.

The coolant level should reach the black top part of the reservoir.

See page 359 for antifreeze/anticorrosion mixture.

## Engine compartment

302

**Adding coolant**

If coolant has to be added, a 50/50 mixture of water and MB anticorrosion/antifreeze should be added.

**Warning!**

- In order to avoid possibly serious burns: Use extreme caution when opening the hood if there are any signs of steam or coolant leaking from the cooling system, or if the coolant temperature gauge indicates that the coolant is overheated.
- Do not remove pressure cap on coolant reservoir if engine temperature is above 194°F (90°C). Allow engine to cool down before removing cap. The coolant reservoir contains hot fluid and is under pressure.
- Using a rag, slowly open cap approximately 1/2 turn to relieve excess pressure. If opened immediately, scalding hot fluid and steam will be blown out under pressure.
- Do not spill antifreeze on hot engine parts. Antifreeze contains ethylene glycol which may burn if it comes into contact with hot engine parts.

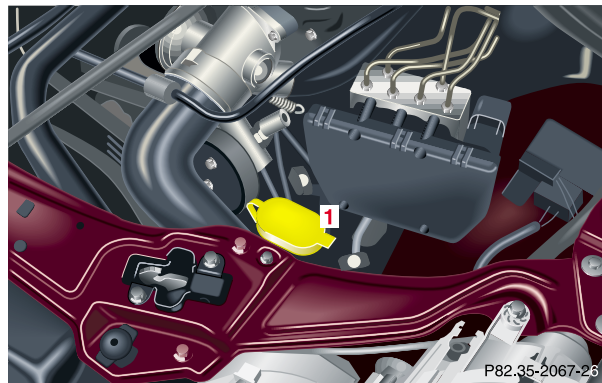
**Windshield and headlamp washer system**

**1** Windshield and headlamp washer fluid reservoir

The reservoir should be refilled with MB Windshield Washer Concentrate and water (or concentrate commercially available premixed windshield washer solvent/antifreeze, depending on ambient temperatures).

Vehicles without headlamp cleaning system:  
Capacity approximately 3.2 US qt (3.0 l)

Vehicles with headlamp cleaning system:  
Capacity approximately 6.4 US qt (6.0 l)

### **Warning!**

**Washer solvent/antifreeze is highly flammable. Do not spill washer solvent/antifreeze on hot engine parts, because it may burn. You can be seriously burned.**

### **Windshield and headlamp washer fluid mixing ratio**

For temperatures above freezing:  
MB Windshield Washer Concentrate “S” and water.

1 part “S” to 100 parts water  
(40 ml “S” to 1 gallon water).

For temperatures below freezing:

MB Windshield Washer Concentrate “S” and commercially available premixed windshield washer solvent/antifreeze.

1 part “S” to 100 parts solvent  
(40 ml “S” to 1 gallon solvent).

## Spare wheel

304

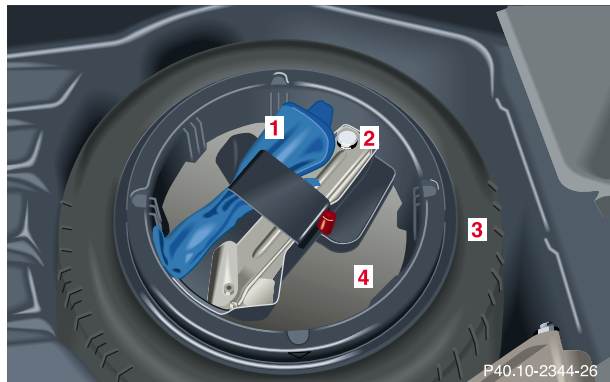
**Spare wheel, vehicle tools, storage compartment**

- 1 Vehicle tool kit and towing eye bolt
- 2 Jack
- 3 Spare wheel
- 4 Storage tray

Lift trunk floor and engage handle in upper edge of trunk.

Always lower trunk floor before closing trunk lid.

To remove the spare wheel:

Take out the vehicle tool kit tray.

Turn the luggage bowl counterclockwise and remove the spare wheel.

To store spare wheel:

Place spare wheel in wheel well and secure it with luggage bowl. Turn luggage bowl clockwise to its stop.

Place vehicle tool kit tray in luggage bowl.

## Vehicle jack

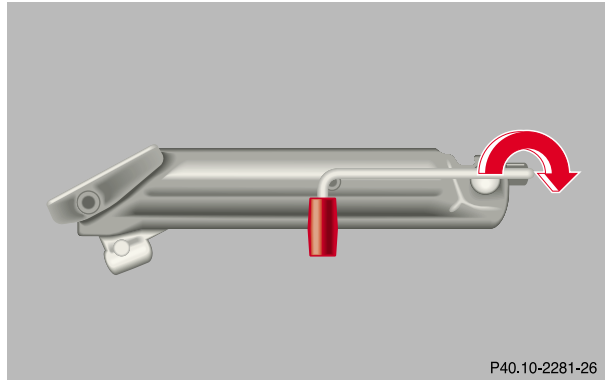

To prepare the jack for use:

Remove the jack from the spare wheel well under the trunk floor.

Push the crank handle up and turn clockwise until it engages (operational position).

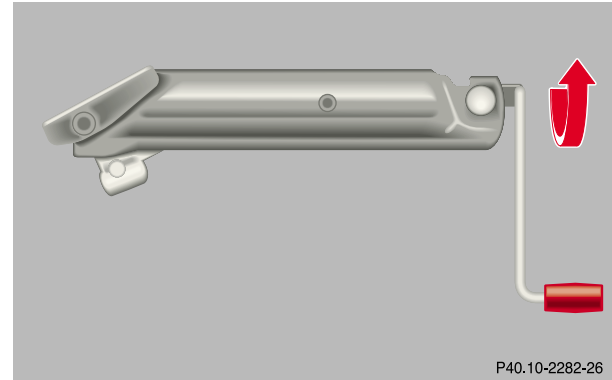

Storing the jack in the trunk:

Before storing the jack, it should be fully collapsed, with handle folded in (storage position).

**Warning!**

The jack is designed exclusively for jacking up the vehicle at the jack take-up brackets built into either side of the vehicle. To help avoid personal injury, use the jack only to lift the vehicle during a wheel change. Never get beneath the vehicle while it is supported by the jack. Keep hands and feet away from the area under the lifted vehicle. Always firmly set parking brake and block wheels before raising vehicle with jack.

Do not disengage parking brake while the vehicle is raised. Be certain that the jack is always vertical when in use, especially on hills. Always try to use the jack on level surface. Be sure that the jack arm is fully seated in the jack take-up bracket. Always lower the vehicle onto sufficient capacity jackstands before working under the vehicle.

**Wheels**

Replace rims or tires with the same designation, manufacturer and type as shown on the original part. See your authorized Mercedes-Benz Center for further information.

See your authorized Mercedes-Benz Center for information on tested and recommended rims and tires for summer and winter operation. They can also offer advice concerning tire service and purchase.

**Tire replacement**

Front and rear tires should be replaced in sets. Rims and tires must be of the correct size and type. For dimensions, see "Technical Data".

We recommend that you break in new tires for approximately 60 miles (100 km) at moderate speed.

It is imperative that the wheel mounting bolts be fastened to a tightening torque of 110 ft.lb. (150 Nm) whenever wheels are mounted.

For rim and tire specifications, refer to “Technical Data”.

### **Warning!**

**Worn, old tires can cause accidents. If the tire tread is badly worn, or if the tires have sustained damage, replace them.**

**When replacing rims, use only genuine Mercedes-Benz wheel bolts specified for the particular rim type. Failure to do so can result in the bolts loosening and possibly an accident.**

### **Rotating wheels**

The wheels can be rotated according to the degree of tire wear while retaining the same direction of travel.

Rotating, however, should be carried out as recommended by the tire manufacturer, before the characteristic tire wear pattern (shoulder wear on front wheels and tread center wear on rear wheels) becomes visible, as otherwise the driving properties deteriorate.

Notes:

Thoroughly clean the inner side of the wheels any time you rotate the wheels or wash the vehicle underside.

The use of retread tires is not recommended. Retread tires may adversely affect the handling characteristics and safety of the vehicle.

Dented or bent rims can cause tire pressure loss and damage to the tire beads. For this reason, check rims for damage at regular intervals. The rim flanges must be checked for wear before a tire is mounted. Remove burrs, if any.

Check and ensure proper tire inflation pressure after rotating the wheels. For tire inflation pressure see inside of fuel filler flap and also page 264.



## Tires, Wheels

308

**Spare wheel****Important!**

The spare wheel rim is mounted with a full size tire of the same type as on the vehicle, and is fully functional. However, that spare wheel rim is weight optimized and has a limited service life of 12 000 miles (20 000 km) use before a standard wheel rim must replace it.

In the case of a flat tire, you may temporarily use the spare wheel.

Do not operate vehicle with more than one spare wheel mounted.

**Warning!**

**The spare wheel rim is for temporary use only. Use for over a total of 12 000 miles (20 000 km) (aggregate of all uses) may cause wheel rim failure leading to an accident and possible injuries.**

**Spare wheel**

The spare wheel rim size is 7 J x 16 H2  
(C 240 Canada only - steel rims 6<sup>1</sup>/<sub>2</sub> J x 16 H2).

In the case of a flat tire or breakdown, you may temporarily use the spare wheel, while observing the following restrictions:

- Do not exceed vehicle speed of 50 mph (80 km/h).
- Drive to the nearest repair facility to have the flat tire repaired or replaced as appropriate.
- Do not operate vehicle with more than one spare wheel mounted.

For additional information, refer to page 352.

### Warning!

The spare wheel rim is for temporary use only. Use for over a total of 12 000 miles (20 000 km) may cause wheel rim failure leading to an accident and possible injuries.

The dimensions of the spare wheel are different from those of road wheels. As a result, the vehicle handling characteristics change when driving with a mounted spare wheel.

The spare wheel should only be used temporarily, and replaced with a regular road wheel as quickly as possible.

### Changing wheels

#### Warning!

The jack is designed exclusively for jacking up the vehicle at the jack take-up brackets built into either side of the vehicle. To help avoid personal injury, use the jack only to lift the vehicle during a wheel change. Never get beneath the vehicle while it is supported by the jack. Keep hands and feet away from the area under the lifted vehicle. Always firmly set parking brake and block wheels before raising vehicle with jack.

Do not disengage parking brake while the vehicle is raised. Be certain that the jack is always vertical when in use, especially on hills. Always try to use the jack on level surface. Be sure that the jack arm is fully seated in the jack take-up bracket. Always lower the vehicle onto sufficient capacity jackstands before working under the vehicle.

## Tires, Wheels

310

Move vehicle to a level area which is a safe distance from the roadway.

1. Set parking brake and turn on hazard warning flasher.
2. Move selector lever to position “P” and turn off engine (manual transmission to 1st or reverse gear).
3. Prevent vehicle from rolling away by blocking wheels with wheel chocks (not supplied with vehicle) or sizable wood block or stone. When changing a wheel on a hill, place chocks on the downhill side blocking both wheels of the other axle. On an level road, place one chock in front of and one behind the wheel that is diagonally opposite to the wheel being changed.

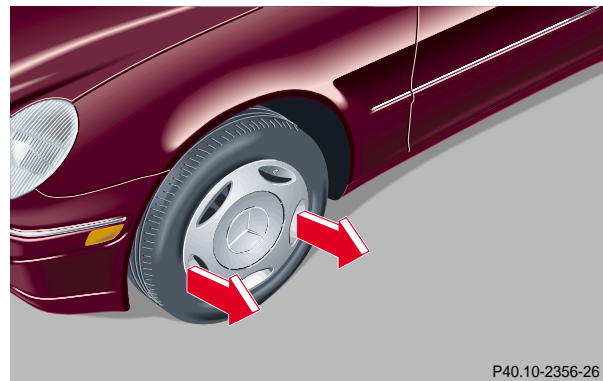

P40.10-2356-26

4. Vehicles with steel rims  
Removal of wheel cover:  
Reach into two opening of the wheel cover and pull.

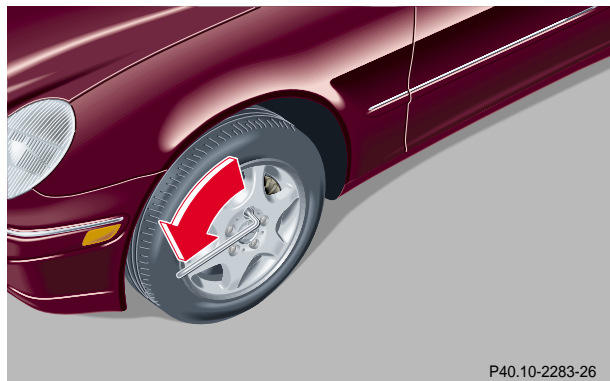

5. Remove the two-piece wheel wrench from the vehicle tool kit and assemble (see page 305).
6. Using the wrench, loosen but do not yet remove the wheel bolts.

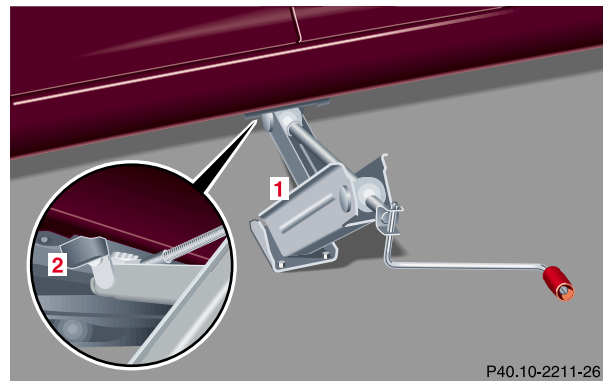

7. Place jack on firm ground. Position jack (1) under the take-up bracket (2) so that it is always vertical (plumb-line) as seen from the side, even if the vehicle is parked on an incline.

The jack take-up brackets are located directly behind the front wheel housings and in front of the rear wheel housings.

8. Jack up the vehicle until the wheel is clear of the ground. Never start engine while vehicle is raised.

## Tires, Wheels

312

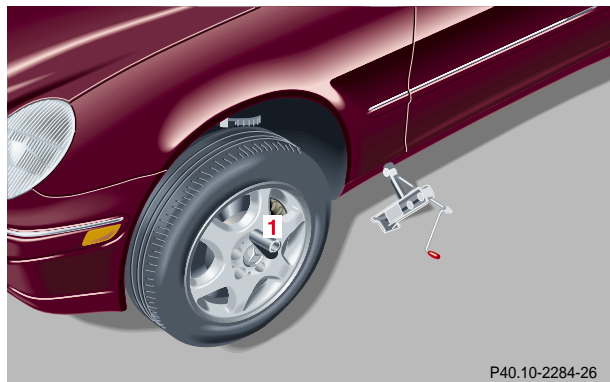

9. Unscrew upper-most wheel bolt and install alignment bolt (1) supplied in the tool kit. Remove the remaining bolts. Keep bolt threads protected from dirt and sand.
10. Remove wheel. Grip wheel from the sides. Keep hands from beneath the wheels.

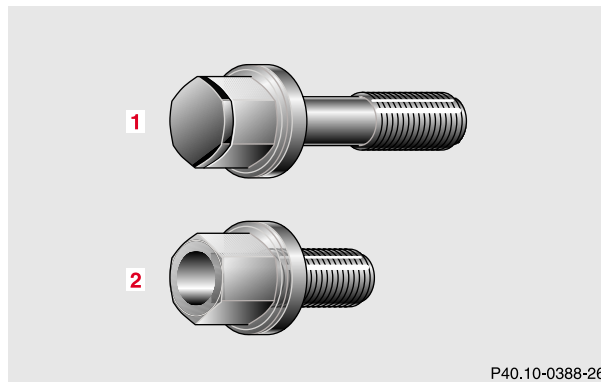

- 1 Wheel bolt for light alloy rims
- 2 Wheel bolt for steel rims (Canada model C 240)

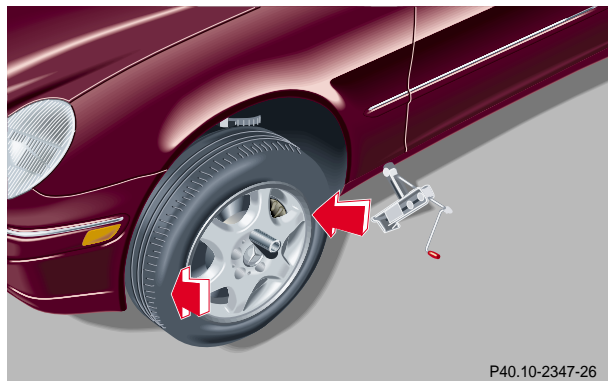

11. Clean contact surfaces of wheel and wheel hub.  
Install spare wheel on wheel hub. Insert wheel bolts and tighten them slightly.

To avoid paint damage, place wheel flat against hub and hold it there while installing first wheel bolt.

Unscrew the alignment bolt to install the last wheel bolt.

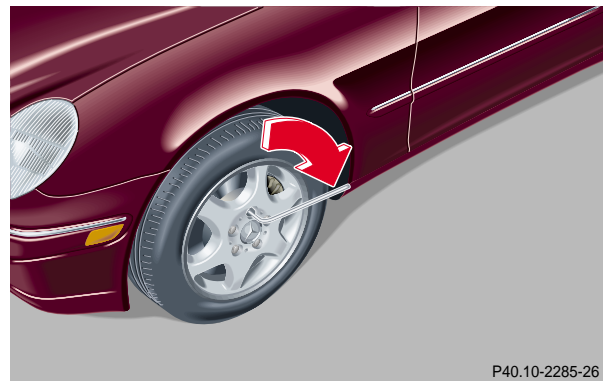

12. Lower vehicle and remove jack.

## Tires, Wheels

314

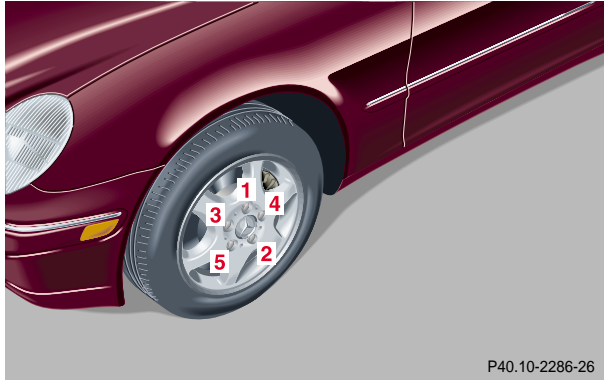

13. Using the wrench, tighten the five bolts evenly, following the sequence illustrated, until all bolts are tight.  
Observe a tightening torque of 80 ft.lb. (110 Nm).

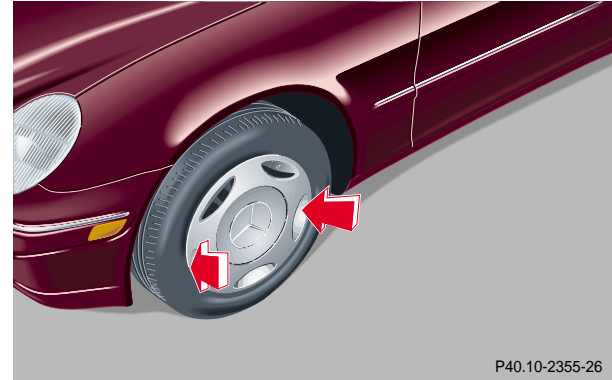

14. Vehicles with steel rims  
Installation of wheel cover:  
Position small wheel cover opening over tire valve and press wheel cover against wheel rim. Now press (do not hit) opposite side of wheel cover against wheel rim until seated. Make certain that the springs of the wheel cover are firmly seated in the outer rim of the steel wheel.

Notes:

Before storing the jack, it should be fully collapsed, with handle folded in.

For proper storage of vehicle jack see page 304.

### **Warning!**

**Always replace wheel bolts that are damaged or rusted.**

**Never apply oil or grease to wheel bolts.**

**Damaged wheel hub threads should be repaired immediately.**

**Incorrect mounting bolts or improperly tightened mounting bolts can cause the wheel to come off. This could cause an accident. Be sure to use the correct mounting bolts.**

### **Tire inflation pressure**

A table (see fuel filler flap) lists the tire inflation pressures specified for Mercedes-Benz recommended tires as well as for the varying operating conditions.

### **Important!**

Tire pressure changes by approximately 1.5 psi (0.1 bar) per 18°F (10°C) of air temperature change. Keep this in mind when checking tire pressure inside a garage – especially in the winter.

Example:

If garage temperature = approximately +68°F (+20°C) and ambient temperature = approximately +32°F (0°C) then the adjusted air pressure = specified air pressure +3 psi (+0.2 bar).

Tire pressures listed for light loads are minimum values offering high driving comfort. Increased inflation pressures for heavy loads produce favorable handling characteristics with lighter loads and are perfectly permissible. The ride of the vehicle, however, will become somewhat harder.

Tire temperature and pressure increase with the vehicle speed. Tire pressure should therefore only be checked and corrected on cold tires. Correct tire pressure in



## Battery

316

warm tires only if pressure has dropped below the pressure listed in the table and the respective operating conditions are taken into consideration.

An underinflated tire due to a slow leak (e.g. due to a nail in the tire) may cause damage such as tread separation, bulging etc. Regular tire pressure checks (including the spare tire) at intervals of no more than 14 days are therefore essential.

If a tire constantly loses air, it should be inspected for damage.

The spare tire should be checked periodically for condition and inflation. Spare tire will age and become worn over time even if never used, and thus should be inspected and replaced when necessary.

**Warning!**

**Do not overinflate tires. Overinflating tires can result in sudden deflation (blowout) because they are more likely to become punctured or damaged by road debris, potholes etc. Follow recommended inflation pressures.**

**Do not overload the tires by exceeding the specified vehicle capacity weight as indicated by the label on the driver's door latch post). Overloading the tires can overheat them, possibly causing a blowout.**

**Battery****Warning!**

**Failure to follow these instructions can result in severe injury or death.**

**Never lean over batteries while connecting, you might get injured.**

**Battery fluid contains sulfuric acid. Do not allow this fluid to come in contact with eyes, skin or clothing. In case it does, immediately flush affected area with water and seek medical help if necessary.**

**A battery will also produce hydrogen gas, which is flammable and explosive. Keep flames or sparks away from battery, avoid improper connection of jumper cables, smoking etc.**

**Important!**

Battery replacement information:

The maintenance-free battery is located in the engine compartment on the right hand side.

The service life of the battery is dependent on its condition of charge. The battery should always be kept sufficiently charged, in order to last an optimum length of time.

**Therefore, we strongly recommend that you have the battery charge checked frequently, and corrected if necessary, especially if you use the vehicle less than approximately 200 miles (300 km) per month, mostly for short distance trips, or if it is not used for long periods of time.**

Only charge a battery with a battery charger after the battery has been disconnected from the vehicle's electrical circuit.

Always disconnect the battery negative lead first and connect last.

When removing and connecting the battery, always make sure that all electrical consumers are off and the electronic key is in starter switch position 0. The battery, its filler caps, the vent tube and the opposite plug must always be securely installed when the vehicle is in operation.

While the engine is running the battery terminal clamps must not be loosened or detached, otherwise the generator and other electronic components would be damaged.

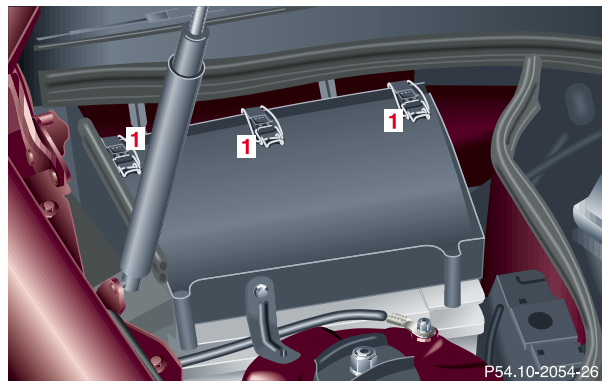

Removal of filter box:

Release three clamps (1) and remove filter box.

Installation of filter box:

Install filter box properly and secure with three clamps (1).

## Jump starting

318

Note:

After reconnecting the battery also set the clock (vehicles with COMAND: see COMAND operator's manual) resynchronize the front seat head restraints, the express feature of the power windows, the sliding/pop-up roof, and the electronic stability program (see individual settings on page 111, head restraints on page 47, power windows on page 184, synchronizing the sliding/pop-up roof on page 188 and electronic stability program on page 260).

### Battery recycling

Batteries contain materials that can harm the environment with improper disposal.

Large 12 Volt storage batteries contain lead.

Recycling of batteries is the preferred method of disposal.

Many states require sellers of batteries to accept old batteries for recycling.

## Jump starting

### Warning!

**Failure to follow these directions will cause damage to the electronic components, and can lead to a battery explosion and severe injury or death.**

**Never lean over batteries while connecting or jump starting, you might get injured.**

**Battery fluid contains sulfuric acid. Do not allow this fluid to come in contact with eyes, skin or clothing. In case it does, immediately flush affected area with water, and seek medical help if necessary.**

**A battery will also produce hydrogen gas, which is flammable and very explosive. Keep flames or sparks away from battery, avoid improper connection of jumper cables, smoking etc.**

**Read all instructions before proceeding.**

## Important!

A discharged battery can freeze at approximately +14°F (-10°C). In that case, it must be thawed out before jumper cables are used. Attempting to jump start a frozen battery can result in it exploding, causing personal injury.

Jumper cable specifications:

- Minimum cable cross-section of 25 mm<sup>2</sup> or approximately 2 AWG
- Maximum length of 11.5 ft. (3.5 m).

If the battery is discharged, the engine should be started with jumper cables and the (12 V) battery of another vehicle.

Only use 12 V battery to jump start your vehicle. Jump starting with more powerful battery could damage the vehicle's electrical systems, which will not be covered by the Mercedes-Benz Limited Warranty.

The battery is located in the engine compartment on the right hand side.

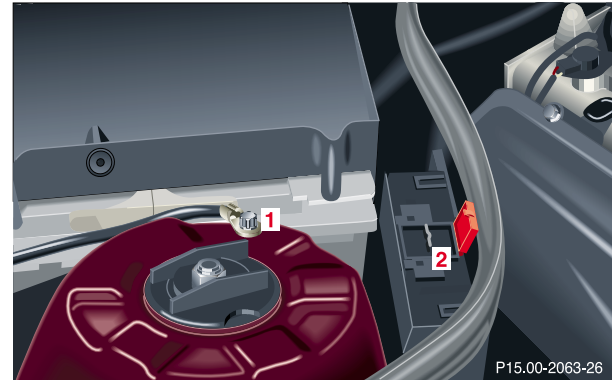

- 1 Negative (-) under hood terminal
- 2 Positive (+) under hood terminal

## Jump starting

320

Proceed as follows:

1. Position the vehicle with the charged battery so that the jumper cables will reach, but never let the vehicles touch. Make sure the jumper cables do not have loose or missing insulation.
2. On both vehicles:
  - Turn off engine and all lights and accessories, except hazard warning flashers or work lights.
  - Apply parking brake and shift selector lever to position “P” (manual transmission to Neutral).

**Important!**

3. Clamp one end of the first jumper cable to the positive (+) under hood terminal of the discharged battery and the other end to the positive (+) terminal of the charged battery. Make sure the cable clamps do not touch any other metal parts.
4. Clamp one end of the second jumper cable to the grounded negative (-) terminal of the charged battery and the final connection to the negative (-) under hood terminal of the disabled vehicle.

**Important!**

5. Start engine of the vehicle with the charged battery and run at high idle. Make sure the cables are not on or near pulleys, fans, or other parts that move when the engine is started. Allow the discharged battery to charge for a few minutes. Start engine of the disabled vehicle in the usual manner.
6. After the engine has started, remove jumper cables by exactly reversing the above installation sequence, starting with the last connection made first. When removing each clamp, make sure that it does not touch any other metal while the other end is still attached.

Note:

If engine does not run after several unsuccessful starting attempts, have it checked at the nearest authorized Mercedes-Benz Center.

Excessive unburned fuel may damage the catalytic converter.

## Towing the vehicle

### Warning!

**Prior to towing the vehicle with all wheels on the ground, make certain that the electronic key is in starter switch position 2.**

**If the electronic key is left in the starter switch position 0 for an extended period of time, it can no longer be turned in the switch. In this case, the steering is locked. To unlock, remove electronic key from starter switch and reinsert.**

## Towing the vehicle

322

**Important!**

When towing the vehicle, please, note the following:

With the automatic central locking activated and the electronic key in starter switch position 2, the vehicle doors lock if the left front wheel as well as the right rear wheel are turning at vehicle speeds of approximately 9 mph (15 km/h) or more.

To prevent the vehicle door locks from locking, deactivate the automatic central locking. See “VEHICLE” under “Individual settings” on page 119.

**Towing of the vehicle should only be done using the properly installed towing eye bolt. Never attach tow cable, tow rope or tow rod to vehicle chassis, frame or suspension parts.**

## Notes:

The selector lever will remain locked in position “P” and the electronic key cannot be turned in the starter switch if the battery is disconnected or discharged. See battery on page 316 or jump starting on page 318.

Transmission selector lever, manually unlocking, see page 325.

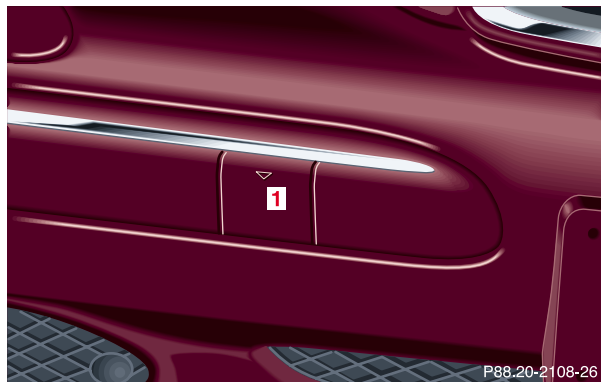
**1** Cover on right side of front bumper

## To remove cover:

Press mark on cover in direction of arrow and lift cover off to reveal threaded hole for towing eye bolt. The towing eye bolt is supplied with the tool kit (located in trunk in spare wheel). Screw towing eye bolt in to its stop and tighten with lug wrench.

## To reinstall cover:

Fit cover and snap into place.



## 2 Cover on right side of rear bumper

To remove cover:

Press mark on cover in direction of arrow and lift cover off to reveal threaded hole for towing eye bolt. The towing eye bolt is supplied with the tool kit (located in trunk in spare wheel). Screw towing eye bolt in to its stop and tighten with lug wrench.

To reinstall cover:

Fit cover and snap into place.

We recommend that the vehicle be transported using flat bed equipment. This method is preferable to other types of towing.

### **Important!**

**To prevent damage during transport, do not tie down vehicle by its chassis or suspension parts.**

Towing restrictions for vehicles with automatic transmission:

The vehicle may be towed with all wheels on the ground and the selector lever in position “N” for distances up to 30 miles (50 km) and at a speed not to exceed 30 mph (50 km/h). The electronic key must be in starter switch position 2.

To be certain to avoid a possibility of damage to the transmission, however, we recommend the drive shaft be disconnected at the rear axle drive flange for any towing beyond a short tow to a nearby garage.

Do not tow with sling-type equipment. Towing with sling-type equipment over bumpy roads will damage radiator and supports.



## Towing the vehicle

324

Use wheel lift, dolly, or flat bed equipment, with electronic key in starter switch turned to position 0.

**Warning!**

**With the engine not running, there is no power assistance for the braking and steering systems. In this case, it is important to keep in mind that a considerably higher degree of effort is necessary to brake and steer the vehicle.**

Note:

To signal turns while being towed with hazard warning flasher in use, turn electronic key in starter switch to position 2 and activate combination switch for left or right turn signal in usual manner – only the selected turn signal will operate.

Upon canceling the turn signal, the hazard warning flasher will operate again.

**Caution!**

If the vehicle is towed with the front axle raised, the engine must be shut off (electronic key in starter switch position 0 or 1). Otherwise, the ESP will immediately be engaged and will apply the rear wheel brakes.

Switch off the tow-away alarm (see page 39) as well as the ESP (see page 260).

## Transmission selector lever, manually unlocking

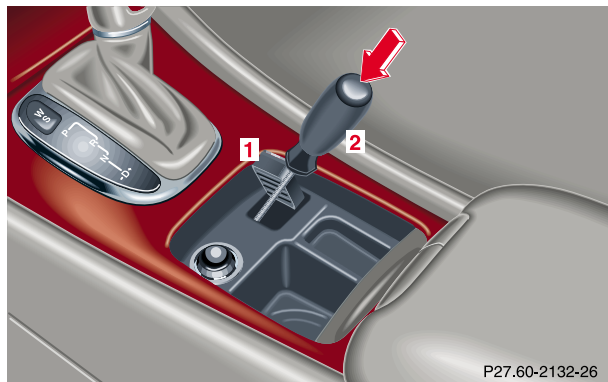

In the case of power failure the transmission selector lever can be manually unlocked, e.g. to tow the vehicle.

To do so, open storage compartment in front of center armrest.

Using a small coin, release the coin holder (1) and swing it aside.

Insert a tool (2), e.g. the screw driver, into the opening below the coin holder. While pushing the tool down, move selector lever from position "P".

After removal of the tool from the opening, reinstall the coin holder.

The selector lever is locked again when moving it to position "P".

## Exterior lamps

326

**Exterior lamps****Headlamp adjustment**

Correct headlamp adjustment is extremely important. Check and readjust headlamps at regular intervals and when a bulb has been replaced.

**Warning!**

**Bulbs and bulb holders can be very hot. Allow the lamp to cool down before changing a bulb.**

**Halogen lamps contain pressurized gas. A bulb can explode if you:**

- touch or move it when hot,
- drop the bulb,
- scratch the bulb.

**Wear eye and hand protection.**

**Replacing bulbs****Warning!**

**Because of high voltage in Xenon lamps, it is dangerous to replace the bulb or repair the lamp and its components. We recommend that you have such work done by a qualified technician.**

## Notes:

To prevent a possible electrical short circuit, switch off lamp prior to replacing a bulb.

When replacing bulbs, install only 12 volt bulbs with the specified watt rating.

When replacing halogen bulbs do not touch glass portion of bulb with bare hands. Use plain paper or a clean cloth.

If the newly installed bulb does not light up, switch the lamp off and on again. If the bulb still does not light up, have the system checked at an authorized Mercedes-Benz Center.

## Headlamp assembly

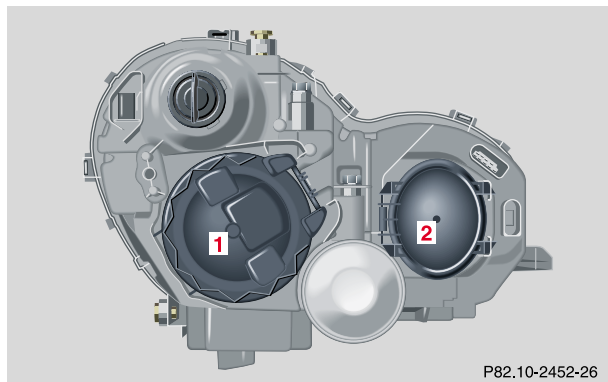

- 1 Headlamp cover for low beam headlamp
- 2 Headlamp cover for parking and standing lamp, and high beam headlamp

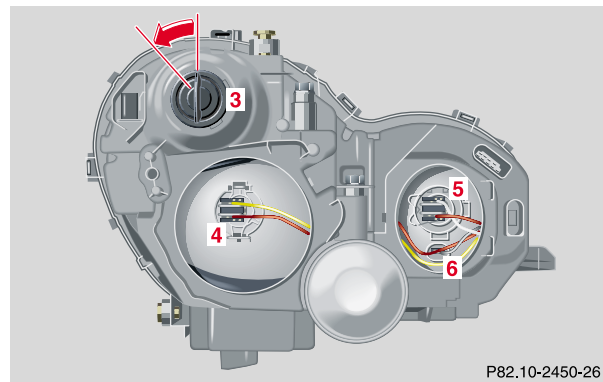

- 3 Bulb socket for turn signal lamp
- 4 Electrical connector for low beam headlamp bulb (Halogen type)
- 5 Electrical connector for high beam headlamp bulb
- 6 Bulb socket for parking and standing lamp

## Exterior lamps

328

**Bulbs for high and low beam**

H7 (55 W)

Open hood.

Press the clamp and remove headlamp cover (1 or 2).

Pull electrical connector off.

Unclip the retainer spring and take out the bulb.

Insert the new bulb so that the base locates in the recess on the holder.

Clip in retainer springs and plug the connector onto the bulb.

Align headlamp cover (1 or 2) and click into place.

**Xenon** (optional)**Bulb for low beam****Warning!**

**Because of high voltage in Xenon lamps, it is dangerous to replace the bulb or repair the lamp and its components. We recommend that you have such work done by a qualified technician.**

**Turn signal lamp**

1156 NA (26.9/5 W/32/4 cp)

Open hood.

Twist bulb socket (3) counterclockwise and pull out. Push bulb into socket, turn counterclockwise and remove.

Insert new bulb in socket, push in and twist clockwise. Reinstall bulb socket.

**Parking and standing lamp**

W 5W

Open hood.

Press the clamp and remove headlamp cover (2).

Pull out bulb socket (6). Remove bulb from socket.

Insert new bulb in socket and push in. Reinstall bulb socket.

Align headlamp cover (2) and click into place.

## Taillamp assemblies

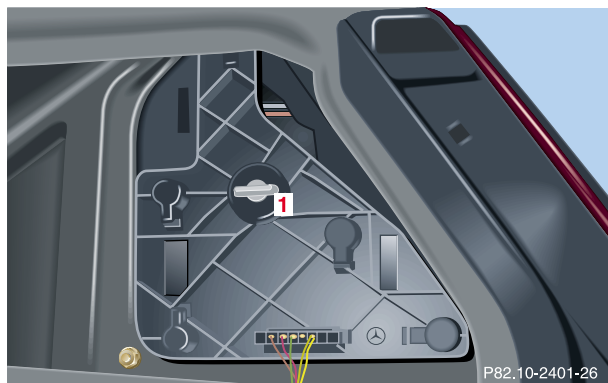

Open trunk lid.

Fold trim to the side.

Turn locking lever (1) to vertical position and remove bulb carrier.

Push bulb into socket, turn counterclockwise and remove.

Insert new bulb in socket, push in and twist clockwise. Reinstall bulb socket.

Reinstall trim.

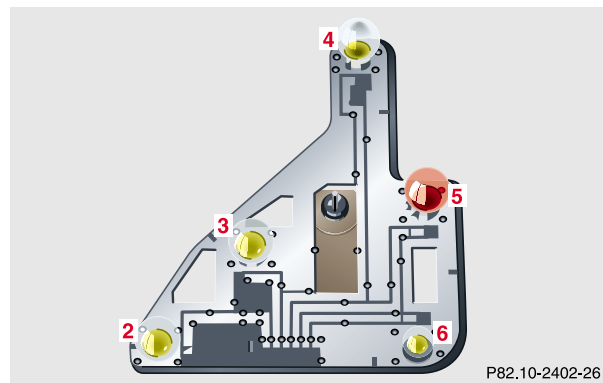

- 2** Driver's side:  
rear fog lamp  
(P 21 W/32 cp bulb)
- 3** Backup lamp (P 21 W/32 cp bulb)
- 4** Stop lamp (P 21 W/32 cp bulb)
- 5** Turn signal lamp (PY 21 W bulb [yellow])
- 6** tail, parking, standing and  
side marker lamp (R 5 W/4 cp bulb)

## Exterior lamps

330

## License plate lamp

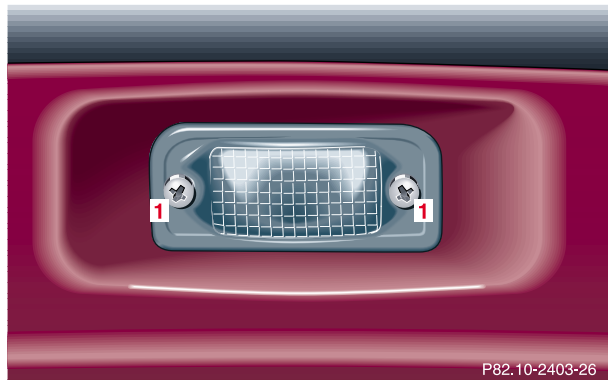

Loosen both securing screws (1), remove lamp and replace tubular lamp (C 5 W/4 cp).

**High mounted stop lamp,  
Additional turn signals on the exterior mirror**

The high mounted stop lamp (3rd brake lamp), and the additional turn signals on the exterior mirrors are equipped with LEDs.

Have the system checked at an authorized Mercedes-Benz Center if a malfunction occurs.

### Standby bulb function

- a) The stop lamps, dimmed, will act as a replacement lamp, if one taillamp stops working.
- b) The left stop lamp acts as a replacement for the rear fog lamp, if it stops working.
- c) The respective fog lamp, dimmed, will act as a replacement lamp, if the left or right standing lamp stops working.

Notes:

The multifunction display will indicate that a bulb has failed. See malfunction and warning messages on page 274.

### Trunk lamp

The trunk lamp will switch off after approximately 10 minutes if the trunk lid is left open.



## Electronic main key

332

**Changing batteries in the electronic main key**

- 1 Transmit buttons
- 2 Lamp for battery check and function control

**Checking batteries**

If one of the transmit buttons (1) is pressed, the battery check lamp (2) lights up briefly – indicating that the batteries are in order.

Change batteries if the battery check lamp (2) does not light up briefly.

**Changing batteries**

Move locking tab (3) in direction of right arrow and remove mechanical key (4, left arrow).



Insert mechanical key (4) in side opening (5) to open latch. Press briefly (do not use mechanical key as lever) to release battery compartment.

Remove mechanical key from side opening.

Carefully remove battery compartment in direction of arrow (6).

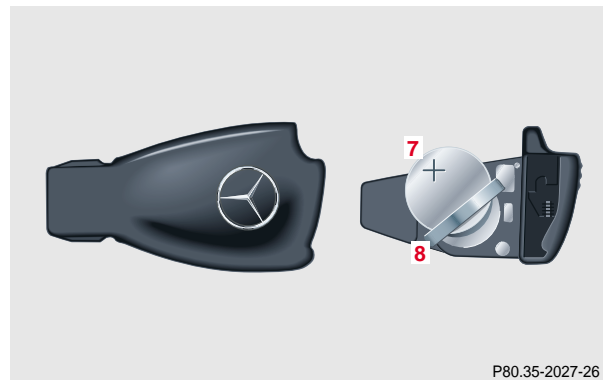

Change batteries (7), inserting new ones under contact spring (8) with plus (+) side facing up.

Return battery compartment into housing until locked in place and slide mechanical key back into electronic main key.

## Emergency engine shut-down

334

**Important!**

Batteries contain materials that can harm the environment if disposed of improperly. Recycling of batteries is the preferred method of disposal. For disposal, please follow manufacturer's recommendation on battery package.

Replacement Battery:  
Lithium, type CR 2025 or equivalent.

**Synchronizing remote control**

The remote control may have to be resynchronized, if the vehicle cannot be locked or unlocked.

To synchronize insert electronic key in starter switch.

The remote control should once again be operational.

**Emergency engine shut-down**

If the engine can no longer be stopped using the electronic key, the engine can be turned off by removing two fuses.

For easy removal of fuses use the fuse extractor (located in the auxiliary fuse box in the trunk) to pull out the fuses marked on the fuse chart as "ENGINE EMERGENCY OFF".

The fuse chart is located in the fuse box in the passenger compartment.

For fuses see page 295.

## Fuel filler flap, manual release

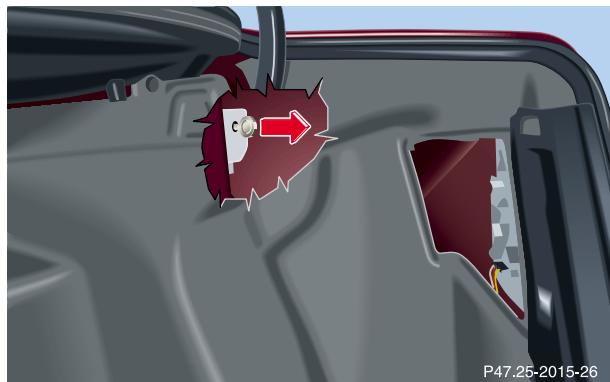

Open the trunk lid and fold right-side taillamp trim aside. Reach inside and pull the release knob (arrow). Open the fuel filler flap.

## Emergency operation of sliding/pop-up roof



The sliding/pop-up roof can be opened or closed manually should an electrical malfunction occur.

The sliding/pop-up roof drive is located behind the lens (1) of the interior overhead light.

## Emergency engine shut-down

336



Slide both locking tabs (2) in direction of arrow, lower rear of cover and remove.

Note:

Do not disconnect electrical connectors.

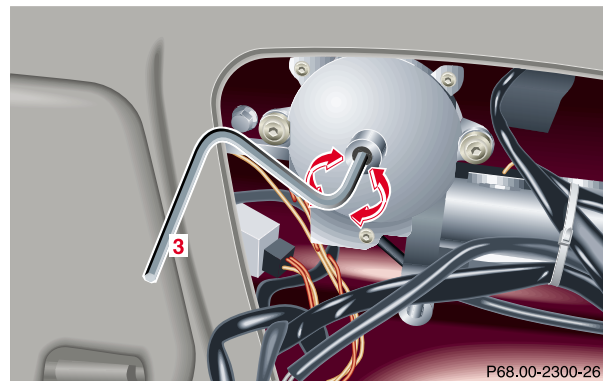

Obtain crank (3) (supplied with vehicle) and insert through hole.

To slide roof closed or to raise the roof at the rear:  
turn crank clockwise.

To slide the roof open or to lower the roof at the rear:  
turn crank counterclockwise.

See page 188 for instructions on synchronizing the  
sliding/pop-up roof after closing manually.

## Replacing wiper blade inserts

For safety reasons, remove electronic key from steering lock before replacing the wiper blades, otherwise the motor can suddenly turn on and cause injury.

Notes:

Do not open engine hood with wiper arm folded forward.

Do not allow the wiper arm to contact the windshield glass without a wiper blade inserted. The glass may be scratched or broken.

Make certain that the wiper blades are properly installed. Improperly installed wiper blades may cause windshield damage.

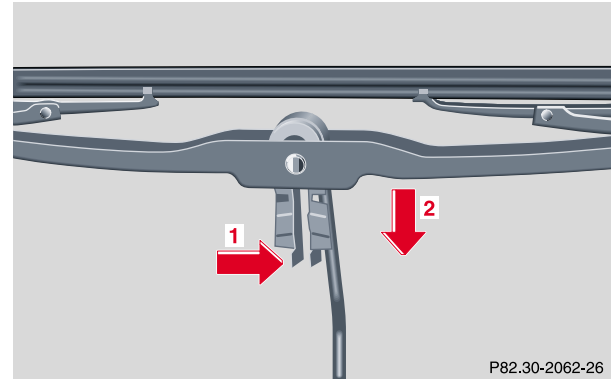

Removal:

Fold wiper arm forward. Press safety tab down (1), push wiper blade downward (2) and remove.

## Replacing wiper blade insert

338

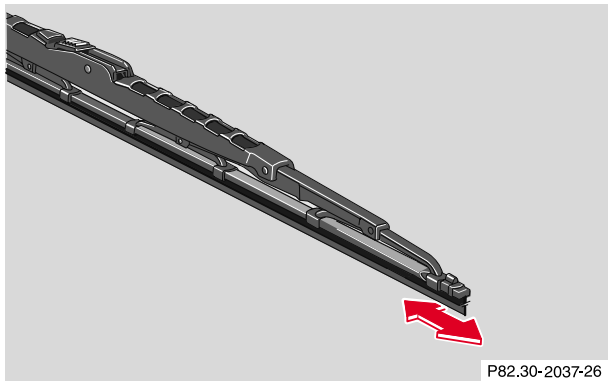

Place wiper blade on firm support. Press down both tabs and slide (direction of arrow) the wiper blade insert out of the retainer claws.

Installation:

Slide (direction of arrow) wiper blade insert into retainer claws until tabs are engaged.

Slide wiper blade onto wiper arm until it locks in place.

## Roof rack

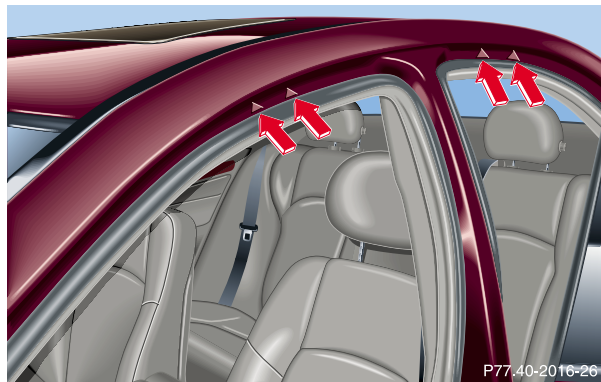

Only mount roof racks to the fastening bolts (see arrows) located under the door weatherstrips.

Use only those roof racks approved by Mercedes-Benz to avoid damage to the vehicle. Follow manufacturer's installation instructions.

## Vehicle care

Cleaning and care of			
the vehicle .....	340	Window cleaning .....	343
Power washer .....	341	Wiper blade .....	343
Tar stains .....	341	Light alloy wheels .....	344
Paintwork, painted body		Instrument cluster .....	344
components .....	341	Steering wheel and gear selector	
Engine cleaning .....	342	lever .....	344
Vehicle washing .....	342	Cup holder .....	344
Ornamental moldings .....	343	Seat belts .....	345
Headlamps, taillamps, turn signal		Headliner and shelf below rear	
lenses .....	343	window .....	345
		Leather upholstery .....	345
		Hard plastic trim items .....	345
		Plastic and rubber parts .....	345



### Cleaning and care of the vehicle

#### Warning!

**Many cleaning products can be hazardous. Some are poisonous, others are flammable. Always follow the instructions on the particular container. Always open your vehicle's doors or windows when cleaning the inside.**

**Never use fluids or solvents that are not designed for cleaning your vehicle.**

In operation, your vehicle is subjected to varying external influences which, if gone unchecked, can attack the paintwork as well as the underbody and cause lasting damage.

Such damage is caused not only by extreme and varying climatic conditions, but also by air pollution, road salt, tar, gravel and stone chipping. Grease and oil, fuel, coolant, brake fluid, bird droppings, insects, tree resins etc. should be removed immediately to avoid paint damage. Frequent washing reduces and/or eliminates the aggressiveness and potency of the above adverse influences.

More frequent washings are necessary to deal with unfavorable conditions; for example, near the ocean, in industrial areas (smoke, exhaust emissions), or during winter operation.

You should check your vehicle from time to time for stone chipping or other damage. Any damage should be repaired as soon as possible to prevent the start of corrosion.

In doing so, do not neglect the underside of the vehicle. A prerequisite for a thorough check is a washing of the underbody followed by a thorough inspection. Damaged areas need to be reundercoated.

Your vehicle has been treated at the factory with a wax-base rustproofing in the body cavities which will last for the lifetime of the vehicle. Post-production treatment is neither necessary nor recommended by Mercedes-Benz because of the possibility of incompatibility between materials used in the production process and others applied later.

We have selected car-care products and compiled recommendations which are specially matched to our vehicles and which always reflect the latest technology. You can obtain Mercedes-Benz approved car-care products at your authorized Mercedes-Benz Center.

Scratches, corrosive deposits, corrosion or damage due to negligent or incorrect care cannot always be removed or repaired with the car-care products recommended here. In such cases it is best to seek aid at your authorized Mercedes-Benz Center.

The following topics deal with the cleaning and care of your vehicle and give important “how-to” information as well as references to Mercedes-Benz approved car-care products.

Additional information can be found in the booklet titled “Vehicle Care Guide”.

### **Power washer**

When using a power washer for cleaning the vehicle always observe manufacturer’s operating instructions.

### **Caution!**

Never use a round nozzle to power wash tires. The intense jet of water can result in damage to the tire.

Always replace a damaged tire.

Always keep the jet of water moving across the surface. Do not aim directly at electrical parts, electrical connectors, seals, or other rubber parts.

### **Tar stains**

Quickly remove tar stains before they dry and become more difficult to remove. A tar remover is recommended.

### **Paintwork, painted body components**

Mercedes-Benz approved Paint Care should be applied when water drops on the paint surface do not “bead up”, normally in 3 to 5 months, depending on climate and washing detergent used.

Mercedes-Benz approved Paint Cleaner should be applied if paint surface shows signs of dirt embedding (i.e. loss of gloss).

Do not apply any of these products or wax if your vehicle is parked in the sun or if the hood is still hot.

Use the appropriate MB-Touch-Up Stick for quick and provisional repairs of minor paint damage (i.e. chips from stones, vehicle doors etc.).

## Cleaning and care of the vehicle

342

**Engine cleaning**

Prior to cleaning the engine compartment make sure to protect electrical components and connectors from the intrusion of water and cleaning agents.

Corrosion protection, such as MB Anticorrosion Wax should be applied to the engine compartment after every engine cleaning. Before applying, all control linkage bushings and joints should be lubricated. The poly-V-belt and all pulleys should be protected from any wax.

**Vehicle washing**

Do not use hot water or wash your vehicle in direct sunlight. Use only a mild car wash detergent, such as Mercedes-Benz approved Car Shampoo.

Thoroughly spray the vehicle with a diffused jet of water. Direct only a very weak spray towards the ventilation intake. Use plenty of water and rinse the sponge and chamois frequently.

Rinse with clear water and thoroughly wipe dry with a chamois. Do not allow cleaning agents to dry on the finish.

Due to the width of the vehicle, prior to running the vehicle through an automatic car wash, fold back the outside mirrors to prevent them from getting damaged.

In the winter, thoroughly remove all traces of road salt as soon as possible.

When washing the underbody, do not forget to clean the inner sides of the wheels.

### **Ornamental moldings**

For regular cleaning and care of very dirty chrome-plated parts, use a chrome cleaner.

### **Headlamps, taillamps, turn signal lenses**

Use a mild car wash detergent, such as Mercedes-Benz approved Car Shampoo, with plenty of water.

To prevent scratches, never apply strong force and use only a soft, non-scratchy cloth when cleaning the lenses. Do not attempt to wipe dirty lenses with a dry cloth or sponge.

### **Window cleaning**

Use a window cleaning solution on all glass surfaces. An automotive glass cleaner is recommended.

Note:

For safety reasons, switch off wipers and remove electronic key from starter switch before cleaning the windshield, otherwise the wiper motor can suddenly turn on and cause injury.

### **Wiper blades**

Clean the wiper blade rubbers with a clean cloth and detergent solution.

Note:

For safety reasons, remove electronic key from starter switch before cleaning the wiper blades, otherwise the wiper motor can suddenly turn on and cause injury.

**Cleaning and care of the vehicle****344****Light alloy wheels**

Mercedes-Benz approved Wheel Care should be used for regular cleaning of the light alloy wheels.

If possible, clean wheels once a week with Mercedes-Benz approved Wheel Care, using a soft bristle brush and a strong spray of water.

Follow instructions on container.

Note:

Use only acid-free cleaning materials. The acid could lead to corrosion.

**Instrument cluster**

Use a gentle dishwashing detergent or mild detergent for delicate fabrics as a washing solution. Wipe with a cloth moistened in lukewarm solution. Do not use scouring agents.

**Steering wheel and gear selector lever**

Wipe with a damp cloth and dry thoroughly or clean with Mercedes-Benz approved Leather Care.

**Cup holder**

Use a gentle dishwashing detergent or mild detergent for delicate fabrics as a washing solution. Wipe with a cloth moistened in lukewarm solution. Do not use scouring agents.

## Seat belts

The webbing must not be treated with chemical cleaning agents. Use only clear, lukewarm water and soap. Do not dry the webbing at temperatures above 176°F (80°C) or in direct sunlight.

### Warning!

**Do not bleach or dye seat belts as this may severely weaken them. In a crash they may not be able to provide adequate protection.**

## Headliner and shelf below rear window

Clean with soft bristle brush, or use a dry-shampoo cleaner in case of excessive dirt.

## Leather upholstery

Using aftermarket seat covers or wearing clothing that have the tendency to give off coloring (e.g. when wet etc.) may cause the upholstery to become permanently discolored. By lining the seats with a proper intermediate cover, contact-discoloration will be prevented.

### Leather Upholstery

Wipe leather upholstery with a damp cloth and dry thoroughly or clean with Mercedes-Benz approved Leather Care. Exercise particular care when cleaning perforated leather as its underside should not become wet.

### MB Tex Upholstery

Pour Mercedes-Benz approved Interior Care onto soft lint-free cloth and apply with light pressure.

## Hard plastic trim items

Pour Mercedes-Benz approved Interior Care onto soft lint-free cloth and apply with light pressure.

## Plastic and rubber parts

Do not use oil or wax on these parts.



## Technical data

Spare parts service .....	348	Engine oil additives .....	357
Warranty coverage .....	348	Air conditioner refrigerant .....	357
Identification labels .....	349	Brake fluid .....	357
Layout of poly-V-belt drive .....	350	Premium unleaded gasoline .....	358
Technical data .....	351	Fuel requirements .....	358
Fuels, coolants, lubricants etc. - capacities .....	355	Gasoline additives .....	359
Engine oils .....	357	Coolants .....	359
		Consumer information .....	361
		Uniform tire quality grading .....	361



### Spare parts service

All authorized Mercedes-Benz Centers maintain a stock of original spare parts required for maintenance and repair work. In addition, strategically located parts distribution centers provide quick and reliable parts service.

More than 300 000 different spare parts, for Mercedes-Benz models, are available.

Mercedes-Benz original spare parts are subjected to stringent quality inspections. Each part has been specifically developed, manufactured or selected for and adapted to Mercedes-Benz vehicles.

Therefore, Mercedes-Benz original spare parts should be installed.

### Important!

The use of non-genuine parts and accessories not authorized by Mercedes-Benz could damage the vehicle which damage is not covered by the Mercedes-Benz Limited Warranty or compromise its durability or safety.

### Warranty coverage

Your vehicle is covered under the terms of the “warranties” printed in the Service and Warranty Information booklet and your authorized Mercedes-Benz Center will exchange or repair any defective parts originally installed on the vehicle in accordance with the terms of the following warranties:

1. New vehicle limited warranty
2. Emission systems warranty
3. Emission performance warranty
4. California, Massachusetts, and Vermont emission control systems warranty

Replacement parts and accessories are covered by the Mercedes-Benz Spare Parts and Accessories warranties, copies of which are available at any Mercedes-Benz Center.

### Loss of Service and Warranty Information Booklet

Should you lose your Service and Warranty Information booklet, have your authorized Mercedes-Benz Center arrange for a replacement. It will be mailed to you.

## Identification labels



**1** Certification label

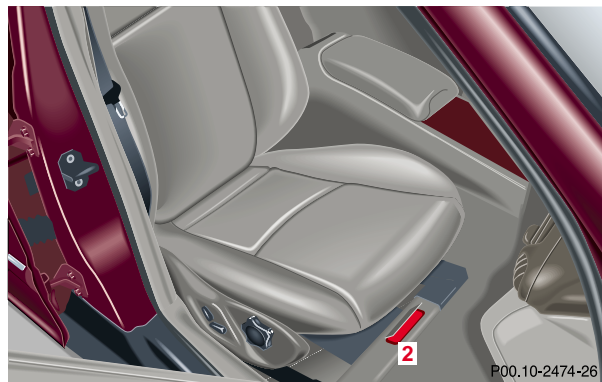

**2** Vehicle Identification Number (VIN)  
(below right rear passenger seat)

## Technical data

350

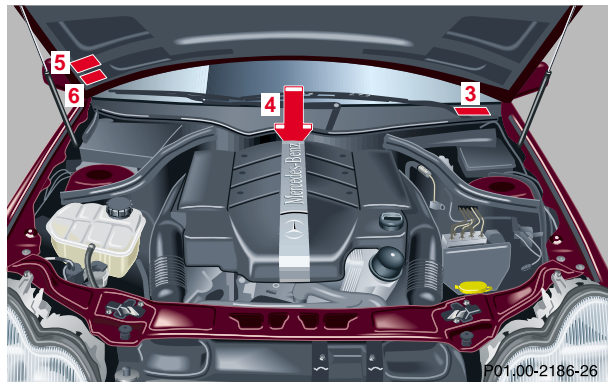

- 3 VIN, visible (lower edge of windshield)
- 4 Engine number
- 5 Emission control label
- 6 Information label, California version  
Vacuum line routing for emission control system

When ordering spare parts, please specify vehicle identification and engine numbers.

## Layout of poly-V-belt drive

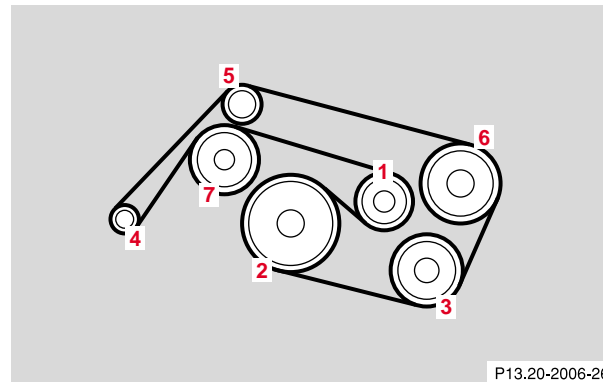

- 1 Automatic belt tensioner
- 2 Crankshaft
- 3 Air conditioner compressor
- 4 Generator (alternator)
- 5 Idler pulley
- 6 Power steering pump
- 7 Coolant pump, fan

## Technical data

<b>Model</b>	<b>C 240</b> (203.061 <sup>1</sup> )	<b>C 320</b> (203.064 <sup>1</sup> )
<b>Engine</b>	112.912	112.946
Mode of operation	4-stroke engine, gasoline injection	4-stroke engine, gasoline injection
No. of cylinders	6	6
Bore	3.54 in (89.90 mm)	3.54 in (89.90 mm)
Stroke	2.68 in (68.20 mm)	3.30 in (84.00 mm)
Total piston displacement	158,5 cu.in. (2597 cm <sup>3</sup> )	195.2 cu.in. (3199 cm <sup>3</sup> )
Compression ratio	10:1	10:1
Output acc. to SAE J 1349	167 hp/6000 rpm (125 kW/6000 rpm)	221 hp/5600 rpm (165 kW/5600 rpm)
Maximum torque acc. to SAE J 1349	130 ft.lb/4500 rpm (240 Nm/4500 rpm)	232 ft.lb/3000 rpm (315 Nm/3000 rpm)
Maximum engine speed	6200 rpm	6000 rpm
Firing order	1-4-3-6-2-5	1-4-3-6-2-5
Poly-V-belt	2390 mm	2390 mm

1 The quoted data apply only to the standard vehicle. See an authorized Mercedes-Benz Center for the corresponding data of all special bodies and special equipment.

Technical data

352

**Rims – Tires**

Model	C 240 (203.061)	C 320 (203.064)	C 240 (Canada only – incl. spare wheel)
Rims (light alloy)	7J x 16 H2	7J x 16 H2	(steel rims) 6 <sup>1</sup> / <sub>2</sub> J x 16 H2
Wheel offset:	1.46 in (37 mm)	1.46 in (37 mm)	1.46 in (37 mm)
All season tires:			
Radial-ply tires	205/55 R16 91 H	205/55 R16 91 H	205/55 R 16 91 H
Winter tires:			
Radial-ply tires	205/55 R16 91 H M+S	205/55 R16 91 H M+S	205/55 R 16 91 H M+S

**Spare wheel**

Rim (light alloy)	7J x 16 H2	7J x 16 H2
Wheel offset:	1.46 in (37 mm)	1.46 in (37 mm)
All season tires:		
Radial-ply tires	205/55 R16 91 H	205/55 R16 91 H

## Electrical system

<b>Model</b>	<b>C 240 (203.061)</b>	<b>C 320 (203.064)</b>
Generator (alternator)	14 V/120 A	14 V/120 A
Starter motor	12V/1.7 kW	12V/1.7 kW
Battery	12V/100 Ah	12V/100 Ah
Spark plugs	Bosch F 8 DPER Beru 14 FGH 8 DPUR X 2 NGK IFR 5 D 10	Bosch F 8 DPER Beru 14 FGH 8 DPUR X 2 NGK IFR 5 D 10
Electrode gap	0.039 in (1.0 mm)	0.039 in (1.0 mm)
Tightening torque	15 – 22 ft.lb (20 – 30 Nm)	15 – 22 ft.lb (20 – 30 Nm)

## Weights

Roof load max.	220 lb (100 kg)
Trunk load max.	220 lb (100 kg)

## Technical data

354

**Main Dimensions****Model****C 240** (203.061)**C 320** (203.064)

Overall vehicle length 178.2 in (4526 mm)

Overall vehicle width 68.0 in (1728 mm)

Overall vehicle height 56.1 in (1426 mm)

Wheel base 106.9 in (2715 mm)

Track, front 59.3 in (1505 mm)

Track, rear 58.1 in (1476 mm)

## Fuels, coolants, lubricants etc. - capacities

Vehicle components and their respective lubricants must match. Therefore use only brands tested and recommended by us. Please refer to the Factory Approved Service Products pamphlet, or inquire at your Mercedes-Benz Center.

	<b>Capacity</b>	<b>Fuels, coolants, lubricants etc.</b>
Engine with oil filter	8.5 US qt (8.0 l)	Recommended engine oils
Automatic transmission	8.5 US qt (8.0 l)	Automatic transmission fluid
Rear axle	1.2 US qt (1.1 l)	Hypoid gear oil SAE 85 W 90
Power steering	approx. 1.1 US qt (1.0 l)	MB Power steering fluid
Front wheel hubs	approx. 2.1 oz (60 g) each	High temperature roller bearing grease
Accelerator control linkage		Hydraulic fluid
Brake system	approx. 0.5 US qt (0.5 l)	MB Brake fluid (DOT 4+)
Cooling system	approx. 9.5 US qt (10.5 l)	MB Anticorrosion/antifreeze
Fuel tank	16.4 US gal (62.0 l)	Premium unleaded gasoline: Posted Octane 91 (Avg. of 96 RON/86 MON)
including a reserve of	2.1 US gal (8.0 l)	



## Fuels, coolants, lubricants etc. - capacities

356

**Capacity**

Air conditioner system

Windshield washer and  
headlamp cleaning systemVehicles without headlamp  
cleaning system:  
Capacity approx. 3.2 US qt  
(3.0 l)Vehicles with headlamp  
cleaning system:  
Capacity approx. 6.4 US qt  
(6.0 l)**Fuels, coolants, lubricants etc.**R-134a refrigerant and special PAG lubricant  
(Never R-12)MB Windshield washer concentrate<sup>1</sup>

- 1 Use MB Windshield Washer Concentrate "S" and water for temperatures above freezing or MB Windshield Washer Concentrate "S" and commercially available premixed windshield washer solvent/antifreeze for temperatures below freezing. Follow suggested mixing ratios, see page 303.

### Engine oils

Engine oils are specifically tested for their suitability in our engines. Therefore, use only engine oils recommended by Mercedes-Benz. Information on recommended brands is available at your authorized Mercedes-Benz Center.

Please follow Service Booklet recommendations for scheduled oil changes. Failure to do so could result in engine damage not covered by the Mercedes-Benz Limited Warranty.

### Engine oil additives

Do not blend oil additives with engine oil. They may be harmful to the engine operation.

Damage or malfunctions resulting from blending oil additives are not covered by the Mercedes-Benz Limited Warranty.

### Air conditioner refrigerant

R-134a (HFC) refrigerant and special PAG lubricating oil is used in the air conditioner system.

Never use R-12 (CFC) or mineral-based lubricating oil, otherwise damage to the system will occur.

### Brake fluid

During vehicle operation, the boiling point of the brake fluid is continuously reduced through the absorption of moisture from the atmosphere. Under extremely hard operating conditions, this moisture content can lead to the formation of bubbles in the system thus reducing the system's efficiency.

The brake fluid must therefore be replaced every two years, preferably in the spring.

It is recommended to use only brake fluid approved by Mercedes-Benz. Your authorized Mercedes-Benz Center will provide you with additional information.

### Premium unleaded gasoline

#### Caution!

To maintain the engine's durability and performance, premium unleaded gasoline must be used. If premium unleaded is not available and low octane fuel is used, follow these precautions:

- have the fuel tank filled only partially with unleaded regular and fill up with premium unleaded as soon as possible,
- avoid full throttle driving and abrupt acceleration,
- do not exceed an engine speed of 3000 rpm, if the vehicle is loaded with a light load such as two persons and no luggage,
- do not exceed  $\frac{2}{3}$  of maximum accelerator pedal position, if the vehicle is fully loaded or operating in mountainous terrain.

### Fuel requirements

Use only Premium unleaded meeting ASTM standard D 439:

The octane number (posted at the pump) must be 91 min. It is an average of both the Research (R) octane number and the Motor (M) octane number:  $(R+M)/2$ . This is also known as ANTI-KNOCK INDEX.

Unleaded gasoline containing oxygenates such as Ethanol, IPA, IBA and TBA can be used provided the ratio of any one of these oxygenates to gasoline does not exceed 10%, MTBE not to exceed 15%.

The ratio of Methanol to gasoline must not exceed 3% plus additional cosolvents.

Using mixtures of Ethanol and Methanol is not allowed. Gasohol, which contains 10% Ethanol and 90% unleaded gasoline, can be used.

These blends must also meet all other fuel requirements such as resistance to spark knock, boiling range, vapor pressure etc.

## Gasoline additives

A major concern among engine manufacturers is carbon build up caused by gasoline. Mercedes-Benz recommends the use of only quality gasoline containing additives that prevent the build up of carbon deposits.

After an extended period of using fuels without such additives, carbon deposits can build up especially on the intake valves and in the combustion area, leading to engine performance problems such as:

- warm-up hesitation,
- unstable idle,
- knocking/pinging,
- misfire,
- power loss.

Do not blend other specific fuel additives with fuel. They only result in unnecessary cost, and may be harmful to the engine operation.

Damage or malfunctions resulting from poor fuel quality or from blending specific fuel additives are not covered by the Mercedes-Benz Limited Warranty.

## Coolants

The engine coolant is a mixture of water and anticorrosion/antifreeze, which provides:

- corrosion protection,
- freeze protection,
- boiling protection (by increasing the boiling point).

The cooling system was filled at the factory with a coolant providing freeze protection to approximately - 22°F (- 30°C) and corrosion protection.

If the antifreeze mixture is effective to - 22°F (- 30°C), the boiling point of the coolant in the pressurized cooling system is reached at approximately 266°F (130°C).

The coolant solution must be used year round to provide the necessary corrosion protection and increase in the boil-over protection. You should have it replaced every 3 years.

To provide the important corrosion protection, the solution must be at least 45% anticorrosion/antifreeze (equals a freeze protection to approximately - 22°F (- 30°C). If you use a solution that is more than 55% anticorrosion/antifreeze (freeze protection to approximately - 49°F (- 45°C), the engine temperature

## Fuels, coolants, lubricants etc. - capacities

360

will increase due to the lower heat transfer capability of the solution. Therefore, do not use more than this amount of anticorrosion/antifreeze.

If the coolant level is low, water and MB anticorrosion/antifreeze should be used to bring it up to the proper level (have cooling system checked for signs of leakage).

The water in the cooling system must meet minimum requirements, which are usually satisfied by normal drinking water. If you are not sure about the water quality, consult your authorized Mercedes-Benz Center.

## Anticorrosion/antifreeze

Your vehicle contains a number of aluminium parts. The use of aluminium components in motor vehicle engines necessitates that anticorrosion/antifreeze coolant used in such engines be specifically formulated to protect the aluminium parts. (Failure to use such anticorrosion/antifreeze coolant will result in a significantly shortened service life.)

Therefore the following product is strongly recommended for use in your vehicle: Mercedes-Benz anticorrosion/antifreeze agent.

Before the start of the winter season (or once a year in the hot southern regions), you should have the anticorrosion/antifreeze concentration checked. The coolant is also regularly checked each time you bring your vehicle to your authorized Mercedes-Benz Center for service.

## Anticorrosion/antifreeze quantity

## Approximately freeze protection

- 35°F (- 37°C)	- 49°F (- 45°C)
--------------------	--------------------

---

4.8 US qt (4.5 l)	5.3 US qt (5.0 l)
----------------------	----------------------

## Consumer information

This has been prepared as required of all manufactures of passenger cars under Title 49, Code of U.S. Federal Regulations, Part 575 pursuant to the “National Traffic and Motor Vehicle Safety Act of 1966”.

### Uniform tire quality grading

Quality grades can be found where applicable on the tire sidewall between tread shoulder and maximum section width. For example:

Tread wear 200    Traction AA    Temperature A

All passenger car tires must conform to federal safety requirements in addition to these grades.

#### Treadwear

The treadwear grade is a comparative rating based on the wear rate of the tire when tested under controlled conditions on a specified government test course. For example, a tire graded 150 would wear one and one-half ( $1\frac{1}{2}$ ) times as well on the government course as a tire graded 100. The relative performance of tires depends upon the actual conditions of their use, however, and

may depart significantly from the norm due to variations in driving habits, service practices and differences in road characteristics and climate.

#### Traction

The traction grades, from highest to lowest are AA, A, B, and C. Those grades represent the tire’s ability to stop on wet pavement as measured under controlled conditions on specified government test surfaces of asphalt and concrete. A tire marked C may have poor traction performance.

#### Warning!

**The traction grade assigned to this tire is based on straightahead braking traction tests, and does not include acceleration, cornering, hydroplaning, or peak traction characteristics.**

## Consumer information

362

## Temperature

The temperature grades are A (the highest), B, and C, representing the tire's resistance to the generation of heat and its ability to dissipate heat when tested under controlled conditions on a specified indoor laboratory test wheel. Sustained high temperature can cause the material of the tire to degenerate and reduce tire life, and excessive temperature can lead to sudden tire failure. The grade corresponds to a level of performance which all passenger car tires must meet under the Federal Motor Vehicle Safety Standard No. 109. Grades B and A represent higher levels of performance on the laboratory test wheel than the minimum required by law.

**Warning!**

**The temperature grade for this tire is established for a tire that is properly inflated and not overloaded. Excessive speed, underinflation, or excessive loading, either separately or in combination, can cause excessive heat build up and possible tire failure.**





**Index****A**

Airbags .....	65	Automatic central locking .....	34
ANTILOCK BRAKE SYSTEM		Automatic climate control .....	146
Malfunction and warning message .....	277	Activated charcoal filter .....	154
Antilock brake system (ABS) .....	258	Adjustable air outlets, rear passenger compartment .....	159
Anti theft alarm system .....	38	Air recirculation .....	153
Ashtrays .....	199	Air volume, manual .....	151
Audio system		Basic setting .....	150
Button and soft key operation .....	163	Defrosting .....	152
Cassette mode .....	169	Display and controls .....	148
CD changer .....	174	Dust filter .....	150
CD mode .....	173	Economy mode .....	155
Operating and display elements .....	161	Front center console storage compartment ventilation .....	158
Operating safety .....	160	Residual engine heat utilization .....	156
Operation .....	163	Special settings .....	151
Operation Audio and telephone .....	160	Windows fogged up on the inside .....	152
Radio mode .....	166	Windows fogged up on the outside .....	152
Telephone operation .....	177	Automatic transmission .....	234
Audio systems .....	98	Fluid level .....	301
Cassette player .....	100	Transmission selector lever, manually unlocking .....	325
CD Player .....	99		
Radio .....	98		

## B

BabySmart™ airbag deactivation system .....	62
Battery .....	316
Block heater .....	252
Brake assist system (BAS) .....	257

## C

Cellular telephone .....	210
Center console .....	18
Central locking switch .....	33
Central locking system .....	25
Automatic central locking .....	34
Central locking switch .....	33
Choosing global or selective mode .....	27
Doors .....	31
General notes .....	24
Locking and unlocking with remote control .....	27
Mechanical keys .....	30
Obtaining replacement keys .....	23
Summer opening/convenience feature .....	29
Vehicle keys .....	22
Check regularly and before a long trip .....	266
Checking engine oil level .....	300

Climate control .....	138
Adjustable air outlets, rear passenger compartment .....	159
Air recirculation .....	144
Basic setting .....	142
Defrosting .....	143
Display and controls .....	140
Dust filter .....	141
Economy mode .....	145
Front center console storage compartment ventilation .....	158
Residual engine heat utilization .....	145
Special settings .....	142
Windows fogged up on the inside .....	143
Windows fogged up on the outside .....	144
COMAND, radio, telephone and two-way radio .....	218
Combination switch .....	134
Control and operation of radio transmitters .....	218
Coolant level .....	301
Coolant temperature gauge .....	124
Cruise control .....	254
Cup holder .....	197

**D**

Dashboard .....	16
Door control panel .....	14
Door entry lamps .....	190
Drive sensibly - Save Fuel .....	244

**E**

Easy-entry/exit feature .....	41
Electronic main key .....	23
Changing batteries .....	332
Synchronizing remote control .....	334
Electronic stability program (ESP) .....	260
Emergency engine shut-down .....	334
Emergency operation of sliding/pop-up roof .....	335
Emergency tensioning retractor (ETR) .....	64
Emergency unlocking in case of accident .....	34
Engine oil consumption .....	129
Engine oil level indicator .....	128
Enlarged cargo area .....	207
ENTRANCE POSITION - malfunction and warning messages .....	292
Exterior lamp switch .....	130
Daytime running lamp mode .....	132
Exterior lamps .....	326

## Additional turn signals on

the exterior mirror .....	330
Bulbs for high and low beam .....	328
Headlamp assembly .....	327
High mounted stop lamp .....	330
License plate lamps .....	330
Parking and standing lamp .....	328
Replacing bulbs .....	326
Taillamp assemblies .....	329
Turn signal lamp .....	328
Exterior mirror adjustment .....	81
Exterior mirror, front passenger side, parking position .....	82

**F**

First aid kit .....	294
Flexible service system (FSS) .....	125
Front airbags .....	65
Front center console storage compartment ventilation .....	158
Front seat adjustment .....	42
Fuel filler flap, manual release .....	335
Fuel reserve warning .....	271
Fuses .....	295

## G

Garage door opener .....	212
Glove box .....	194

## H

Hazard warning flasher switch .....	137
Head restraints	
Rear seat .....	52
Head restraints, front seats	
Removal and installation .....	47
Headlamp cleaning system .....	133
Headlamp mode .....	131
Heated seats .....	50

## I

Identification labels .....	349
Individual settings .....	111
"CONVENIENCE" .....	121
"INSTRUMENT CLUSTER" .....	113
"LIGHTING" .....	117
"VEHICLE" .....	119
Infant and child restraint systems .....	73

Child seat mounts .....	76
Installation .....	75
Instrument cluster .....	88
Instruments and controls .....	12
Center console .....	18
Dashboard .....	16
Door control panel .....	14
Overhead control panel .....	15
Interior .....	193
Interior lighting .....	189

## J

Jack .....	305
Jump starting .....	318

## L

Lighter .....	201
Loading instructions	
(Vehicle with enlarged cargo area) .....	209
Locator lighting .....	133
Locking the vehicle with remote control .....	27

**M**

Maintenance .....	219
Malfunction/warning message memory .....	109
Manual seat .....	45, 48
Manual transmission .....	233
Memory function .....	85
Mirror, exterior, parking position, front passenger side .....	82
Multicontour seat .....	49
Multifunction display .....	92
Coolant temperature .....	96
Engine oil level indicator .....	96
FSS .....	96
Individual settings .....	111
Tire inflation pressure monitor .....	96
Trip and main odometer .....	96
Vehicle speed .....	96
Multifunction steering wheel .....	92

**N**

Navigation system .....	106
Night security illumination .....	132

**O**

On-board diagnostic system .....	268
Overhead control panel .....	15

**P**

Panic button .....	30
Parcel net in front passenger footwell .....	202
Parking brake .....	243
Power windows .....	184
Blocking of rear door window operation .....	186
Express opening and closing .....	185
Opening and closing .....	29
Synchronizing power windows .....	186
Problems with your vehicle .....	8
Product information .....	1

**R**

Rain sensor .....	135
Rear passenger compartment adjustable air outlets .....	159
Rear window defroster .....	157
Rear window sunshade .....	191

Removal and installation of front seat head restraints .....	47
Replacement keys	
Obtaining .....	23
Replacing wiper blade insert .....	337
Reporting Safety Defects .....	9
REST .....	145, 156
Roof rack .....	338

## S

Seat belt nonusage warning system .....	56
Seat belts .....	55
Fastening .....	58
Operation .....	59
Unfastening .....	59
Warning lamp .....	273
Seat belts and integrated restraint system .....	55
Seats	
Front seat adjustment .....	42
Manual seat .....	45
Power seat .....	43
Setting the audio volume .....	123
Side impact airbags .....	68

Ski sack .....	202
Sliding/pop-up roof .....	187
Opening and closing .....	29
Synchronizing .....	188
Spare wheel .....	308
Spare wheel, vehicle tools, storage compartment ....	304
Split folding rear seat bench .....	207
Standby bulb function .....	331
Start lock-out .....	24
Starter switch .....	230
Starting and turning off the engine .....	232
STEER. WHEEL ADJUST. - malfunction and warning messages .....	292
Steering lock	
See starter switch .....	230
Steering wheel	
Easy-entry/exit feature .....	41
Steering wheel adjustment	
electrical .....	79
manual .....	77
Storage compartments and armrests .....	193
Storing mirror positions .....	81
Storing seat positions .....	44
Stowing things in the vehicle .....	294
Sun visors .....	192
Supplemental Restraint System (SRS) .....	63

## Index

370

**T**

Technical data .....	351
Tele Aid .....	220
Initiating an emergency call .....	222
Telephone .....	101
Incoming call .....	105
Redialing .....	103
Telephone book .....	101
Telephone, general .....	211
Telephones and two-way radios .....	218
Telescoping steering column - malfunction and warning messages .....	292
The first 1 000 miles (1 500 km) .....	219
Tire inflation pressure .....	315
Tow-away alarm .....	39
Towing the vehicle .....	321
Transmission selector lever, manually unlocking .....	325
Trip computer .....	107
Trunk .....	35
Opening .....	28
Release switch .....	37
Trunk lamp .....	331

**U**

Unlocking the vehicle with remote control .....	27
---	----

**V**

Vanity mirrors .....	192
Vehicle keys .....	22
Vehicle tools .....	304

**W**

What you should know at the gas station .....	264
Wheels .....	306
Where to find it .....	7
Window curtain airbag .....	68
Windshield washer system .....	302
Wiper blade Replacing insert .....	337

## Service and Literature

Your authorized Mercedes-Benz Center has trained technicians and original Mercedes-Benz parts to service your vehicle properly. For expert advice and quality service, see your authorized Mercedes-Benz Center.

If you are interested in obtaining service literature for your vehicle, please contact your authorized Mercedes-Benz Center. We consider this the best way for you to obtain accurate information for your vehicle.

For further information you can find us on the Mercedes-Benz web-site *www.mbusa.com*.

### **Warning!**

**To help avoid personal injury, be extremely careful when performing any service work or repairs. Improper or incomplete service or the use of incorrect or inappropriate parts or materials may damage the vehicle or its equipment, which may in turn result in personal injury.**

**If you have any question about carrying out some service, turn to the advice of an authorized Mercedes-Benz Center.**

We reserve the right to modify the technical details of the vehicle as given in the data and illustrations of this Operator's Manual. Reprinting, translation and copying, even of excerpts, is not permitted without our prior authorization in writing.

Title illustration no. P00.00-3006-26

Press time 03/31/00

MBUSA/TI

Printed in the U.S.A.



